

$\Pi_0 = \text{aire de Neptune} \pm 1 \text{ mm}$

$\Pi_0 \rightarrow \Pi_{63}$

73 398,230 855 942 92 km

$\pi$  (pi)  
0-63

# NEPTUNE

103 800,773 530 665 89 km

rayon équatorial : 24 764 km  
rayon polaire : 24 341 km

aire calculée : 7 618 793 138,629 264 km<sup>2</sup>

rectangle d'aire égale à Neptune et de ratio  $1:\sqrt{2}$  :  
largeur : 73 398,230 855 942 92 km  
hauteur : 103 800,773 530 665 89 km

Cette série est imprimée au format a57 (193 × 273 mm), le premier format pouvant être apposé sur un format A4.

73 398 230 855 mm

П8

П10

П11

П9

П6

П7

П4

П5

П2

П3

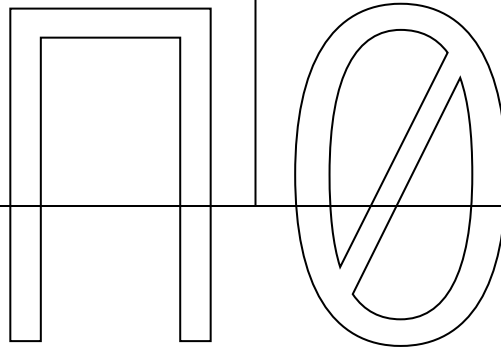

103 800 773 530 mm

П1

73 398 230 855 × 103 800 773 530 mm

1 par П0

≈ 0,147 km<sup>2</sup> perdus suite aux arrondies

П0 ≡ pi zéro

51 900 386 765 mm

П9

П11  
П12  
П10

П7

П8

П5

П6

П3

П4

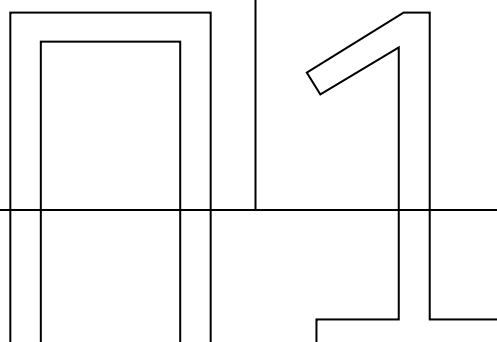

73 398 230 855 mm

П2

51 900 386 765 × 73 398 230 855 mm

2 par П0

≈ 0,147 km<sup>2</sup> perdus suite aux arrondies

П1 ≡ pi un

36 699 115 427 mm

П10

П12  
П13

П11

П8

П9

П6

П7

П4

П5

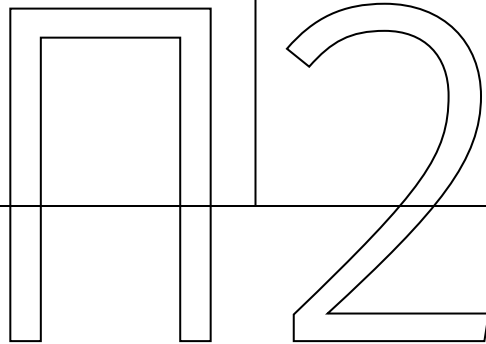

51 900 386 765 mm

П3

36 699 115 427 × 51 900 386 765 mm

4 par П0

≈ 0,251 km<sup>2</sup> perdus suite aux arrondies

П2 ≡ pi deux

25 950 193 382 mm

П11

П13  
П14  
П12

П9

П10

П7

П8

П5

П6

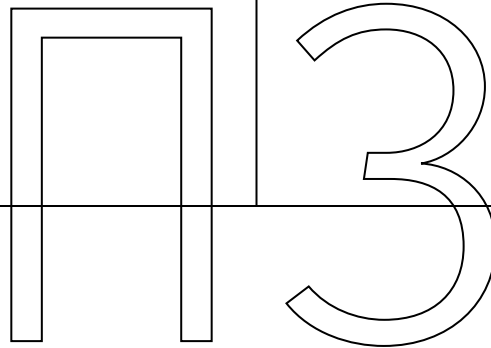

36 699 115 427 mm

П4

25 950 193 382 × 36 699 115 427 mm

8 par П0

≈ 0,397 km<sup>2</sup> perdus suite aux arrondies

П3 ≡ pi trois

18 349 557 713 mm

Π12

Π14  
Π15

Π13

Π10

Π11

Π8

Π9

Π6

Π7

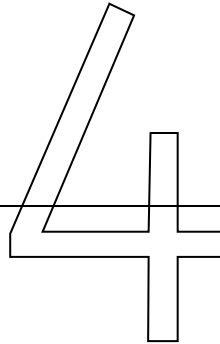
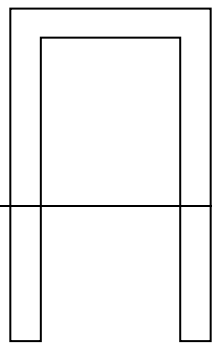

25 950 193 382 mm

Π5

18 349 557 713 × 25 950 193 382 mm

16 par Π0

≈ 0,605 km<sup>2</sup> perdus suite aux arrondies

Π4 ≡ pi quatre

12 975 096 691 mm

Π13

Π15  
Π16  
Π14

Π11

Π12

Π9

Π10

Π7

Π8

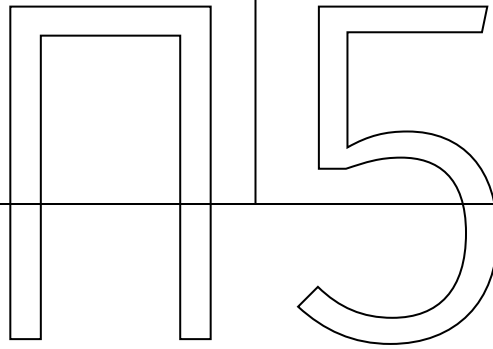

18 349 557 713 mm

Π6

12 975 096 691 × 18 349 557 713 mm

32 par Π0

≈ 0,605 km<sup>2</sup> perdus suite aux arrondies

Π5 ≡ pi cinq



9 174 778 856 mm

П14

П16

П17

П15

П12

П13

П10

П11

П8

П9

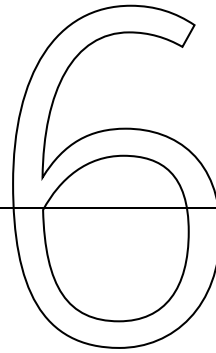
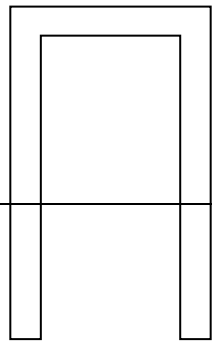

12 975 096 691 mm

П7

9 174 778 856 × 12 975 096 691 mm

64 par П0

≈ 1,02 km<sup>2</sup> perdus suite aux arrondies

П6 ≡ pi six

6 487 548 345 mm

П15

П17  
П18

П13

П16

П14

П11

П12

П9

П10

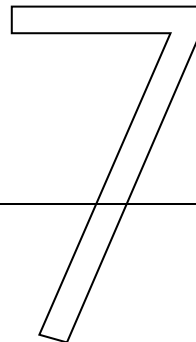
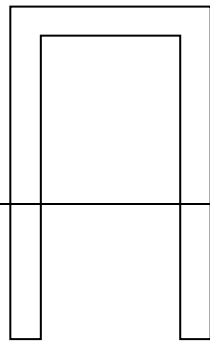

9 174 778 856 mm

П8

6 487 548 345 × 9 174 778 856 mm

128 par П0

≈ 1,607 km<sup>2</sup> perdus suite aux arrondies

П7 ≡ pi sept

4 587 389 428 mm

П16

П18

П19

П17

П14

П15

П12

П13

П10

П11

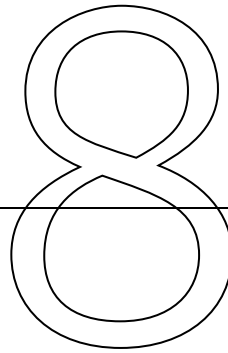
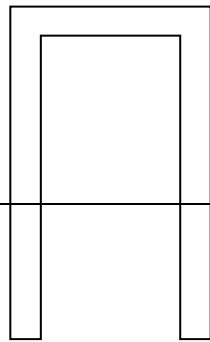

6 487 548 345 mm

П9

4 587 389 428 × 6 487 548 345 mm

256 par П0

≈ 1,607 km<sup>2</sup> perdus suite aux arrondies

П8 ≡ pi huit

3 243 774 172 mm

П17

П19  
П20

П18

П15

П16

П13

П14

П11

П12

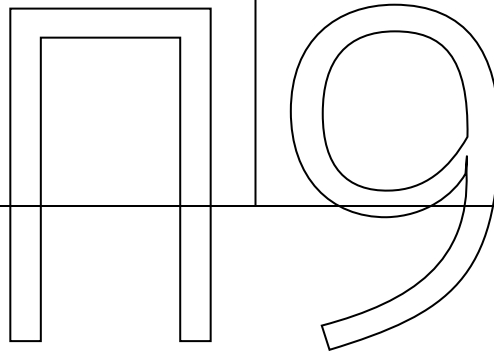

4 587 389 428 mm

П10

3 243 774 172 × 4 587 389 428 mm

512 par П0

≈ 2,782 km<sup>2</sup> perdus suite aux arrondies

П9 ≡ pi neuf

2 293 694 714 mm

П18



П16

П19

П17

П14

П15

П12

П13

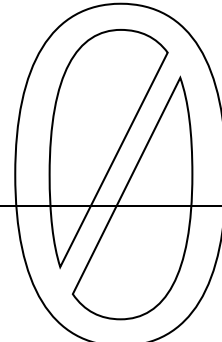
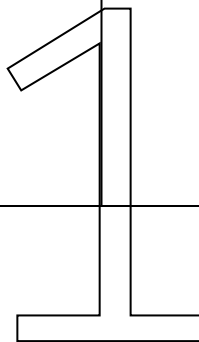
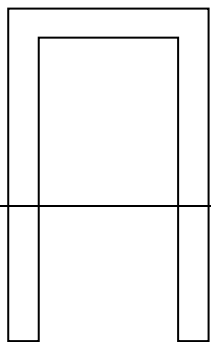

3 243 774 172 mm

П111

2 293 694 714 × 3 243 774 172 mm

1 Ø24 par П0

≈ 2,782 km<sup>2</sup> perdus suite aux arrondies

П10 ≡ pi dix

π21	π22
π20	π23

π19

π20

1 621 887 086 mm

π17

π18

π15

π16

π13

π14

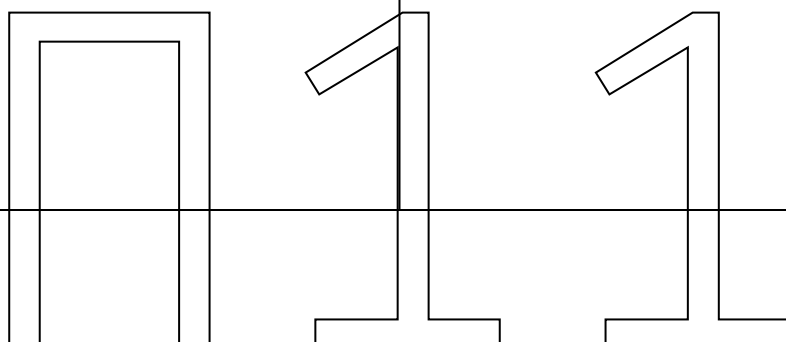

2 293 694 714 mm

π12

1 621 887 086 × 2 293 694 714 mm

2 048 par π0

≈ 2,782 km<sup>2</sup> perdus suite aux arrondies

π11 ≡ pi onze

1 146 847 357 mm

π20

π22  
π23

π21

π18

π19

π16

π17

π14

π15

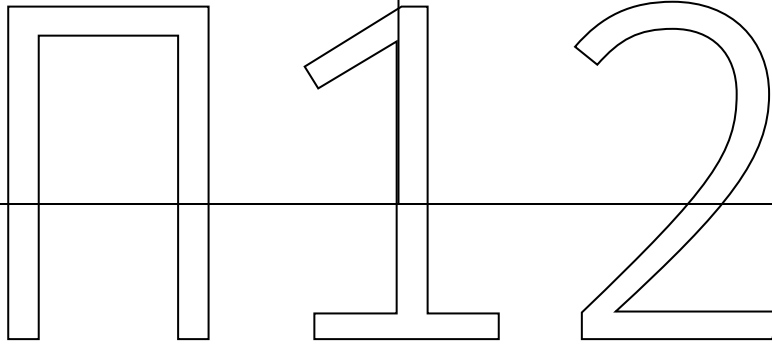

1 621 887 086 mm

π13

1 146 847 357 × 1 621 887 086 mm

4 096 par π0

≈ 2,782 km<sup>2</sup> perdus suite aux arrondies

π12 ≡ pi douze

810 943 543 mm

π21



π19

π20

π17

π18

π15

π16

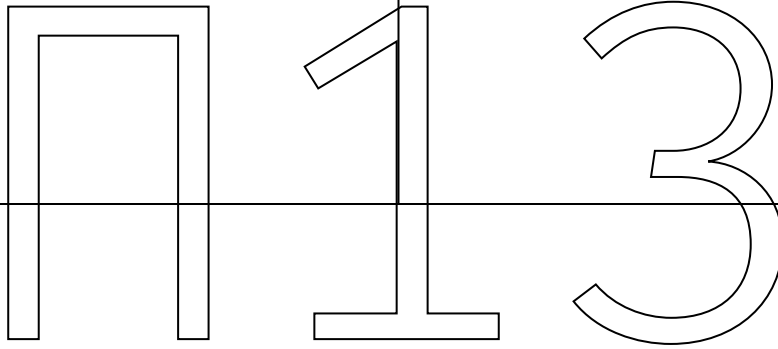

1 146 847 357 mm

π14

810 943 543 × 1 146 847 357 mm

8 192 par π0

≈ 2,782 km<sup>2</sup> perdus suite aux arrondies

π13 ≡ pi treize



573 423 678 mm

Π22

Π24  
Π25

Π23

Π20

Π21

Π18

Π19

Π16

Π17

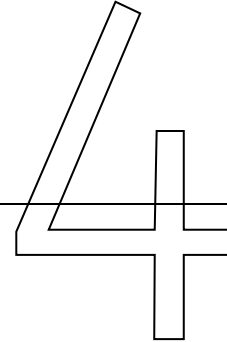
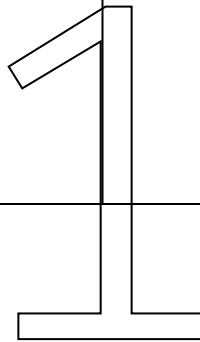
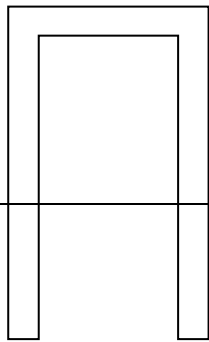

810 943 543 mm

Π15

573 423 678 × 810 943 543 mm

16 384 par Π0

≈ 9,425 km<sup>2</sup> perdus suite aux arrondies

Π14 ≡ pi quatorze

405 471 771 mm

π23

π25  
π26

π24

π21

π22

π19

π20

π17

π18

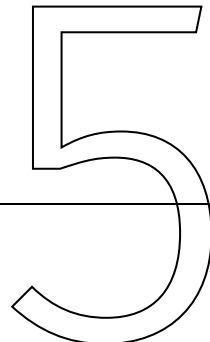
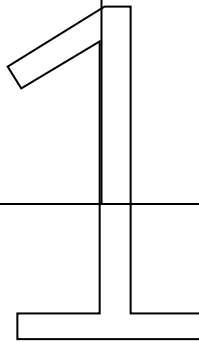
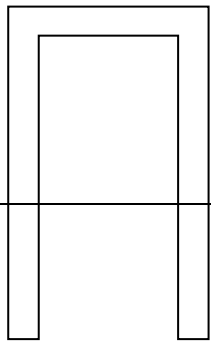

573 423 678 mm

π16

405 471 771 × 573 423 678 mm

32 768 par π0

≈18,82 km<sup>2</sup> perdus suite aux arrondies

π15 ≡ pi quinze

286 711 839 mm

П24

П26  
П27

П25

П22

П23

П20

П21

П18

П19

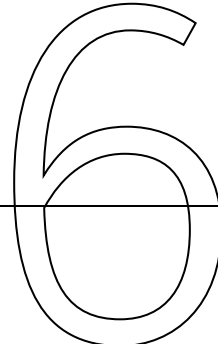
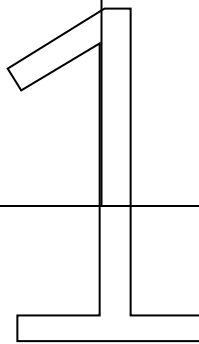
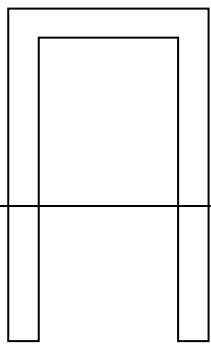

405 471 771 mm

П17

286 711 839 × 405 471 771 mm

65 536 par П0

≈ 18,82 km<sup>2</sup> perdus suite aux arrondies

П16 ≡ pi seize

202 735 885 mm

π25

π27  
π28

π26

π23

π24

π21

π22

π19

π20

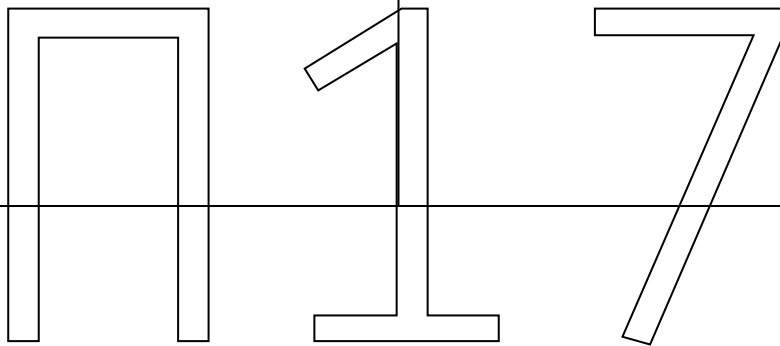

286 711 839 mm

π18

202 735 885 × 286 711 839 mm

131 072 par π0

≈ 37,61 km<sup>2</sup> perdus suite aux arrondies

π17 ≡ pi dix-sept

143 355 919 mm

π26

π28  
π29

π27

π24

π25

π22

π23

π20

π21

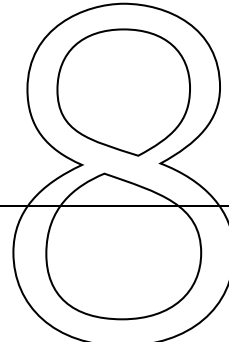
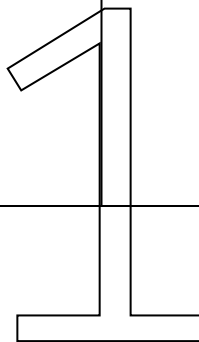
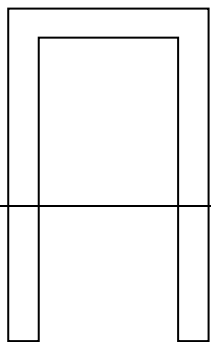

202 735 885 mm

π19

143 355 919 × 202 735 885 mm

262 144 par π0

≈ 64,183 km<sup>2</sup> perdus suite aux arrondies

π18 ≡ pi dix-huit

101 367 942 mm

π27



π25

π26

π23

π24

π21

π22

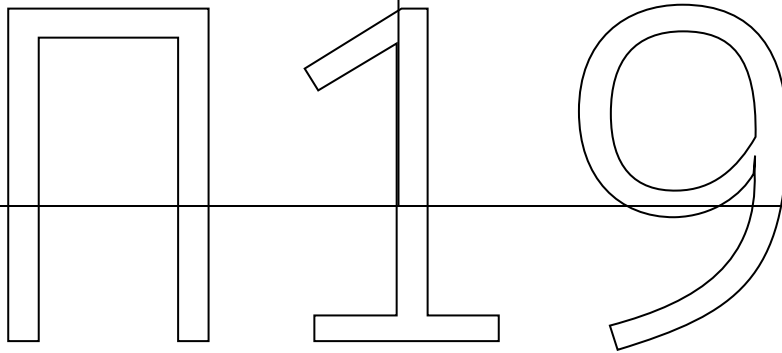

143 355 919 mm

π20

101 367 942 × 143 355 919 mm

524 288 par π0

≈ 101,763 km<sup>2</sup> perdus suite aux arrondies

π19 ≡ pi dix-neuf

71 677 959 mm

π28

π30

π31

π29

π26

π27

π24

π25

π22

π23

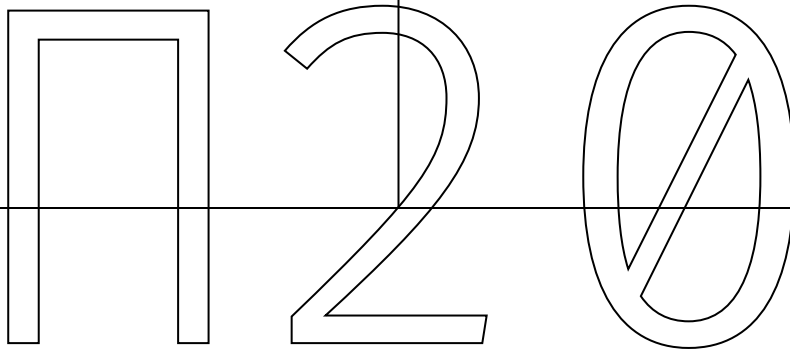

101 367 942 mm

π21

71 677 959 × 101 367 942 mm

1 048 576 par π0

≈ 154,909 km² perdus suite aux arrondies

π20 ≡ pi vingt

50 683 971 mm

П29

П31  
П32  
П30

П27

П28

П25

П26

П23

П24

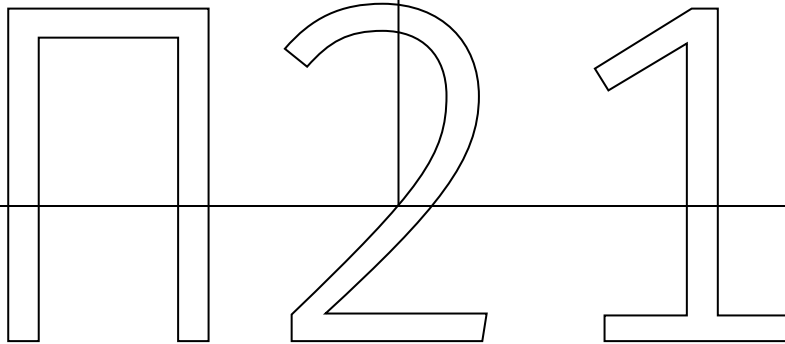

71 677 959 mm

П22

50 683 971 × 71 677 959 mm

2 097 152 par П0

≈ 154,909 km² perdus suite aux arrondies

П21 ≡ pi vingt et un



35 838 979 mm

П30

П32  
П33  
П31

П28

П29

П26

П27

П24

П25

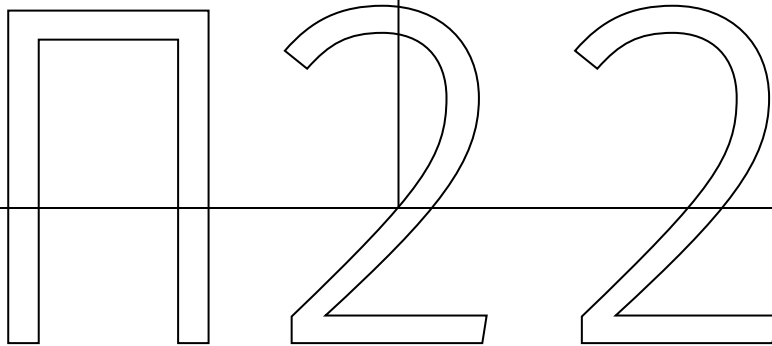

50 683 971 mm

П23

35 838 979 × 50 683 971 mm

4 194 304 par П0

≈ 261,201 km<sup>2</sup> perdus suite aux arrondies

П22 ≡ pi vingt-deux

25 341 985 mm

П31

П33  
П34  
П32

П29

П30

П27

П28

П25

П26

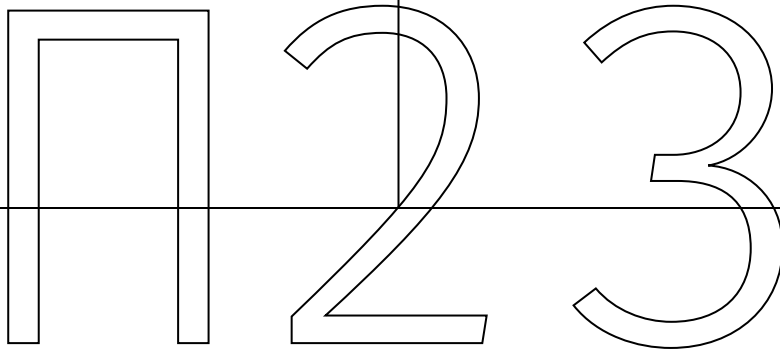

35 838 979 mm

П24

25 341 985 × 35 838 979 mm

8 388 608 par Π0

≈ 411,52 km² perdus suite aux arrondies

Π23 ≡ pi vingt-trois

17 919 489 mm

П32

П34  
П35

П33

П30

П31

П28

П29

П26

П27

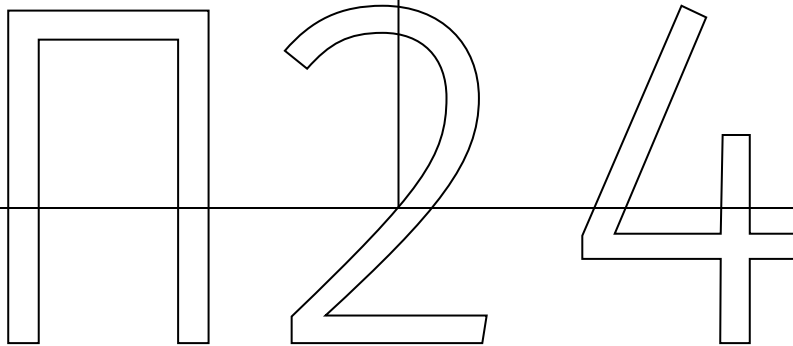

25 341 985 mm

П25

17 919 489 × 25 341 985 mm

16 777 216 par П0

≈ 624,104 km<sup>2</sup> perdus suite aux arrondies

П24 ≡ pi vingt-quatre

12 670 992 mm

П33



П31

П32

П29

П30

П27

П28

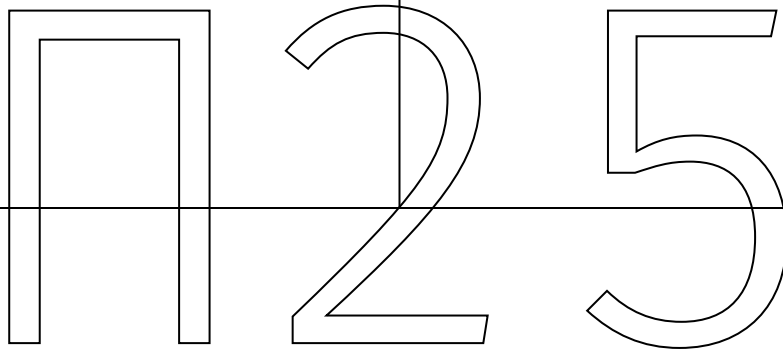

17 919 489 mm

П26

12 670 992 × 17 919 489 mm

33 554 432 par П0

≈ 924,743 km<sup>2</sup> perdus suite aux arrondies

П25 ≡ pi vingt-cinq

8 959 744 mm

П34

П36  
П37

П35

П32

П33

П30

П31

П28

П29

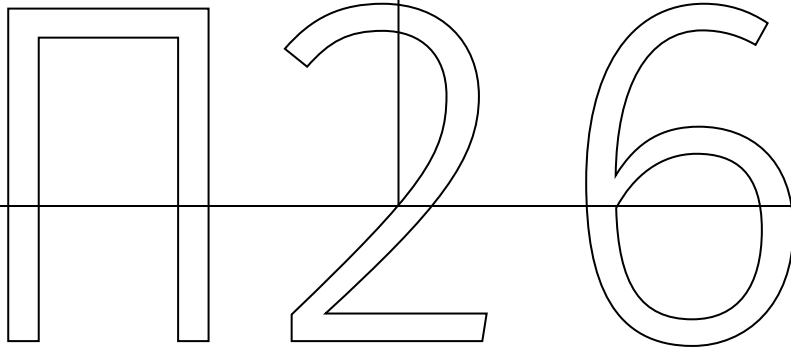

12 670 992 mm

П27

8 959 744 × 12 670 992 mm

67 108 864 par П0

≈ 1 349,911 km<sup>2</sup> perdus suite aux arrondies

П26 ≡ pi vingt-six

6 335 496 mm

П35

П37  
П38  
П36

П33

П34

П31

П32

П29

П30

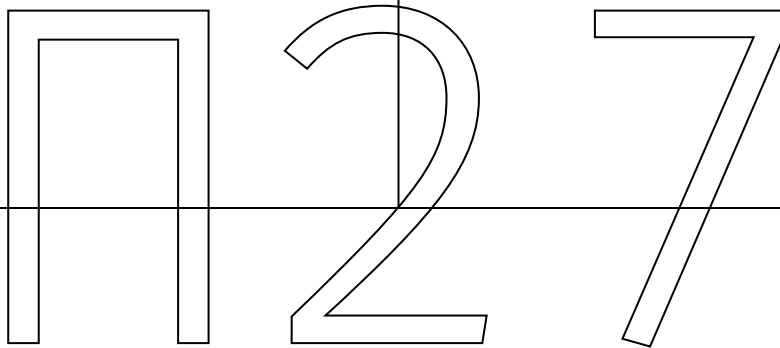

8 959 744 mm

П28

6 335 496 × 8 959 744 mm

134 217 728 par П0

≈ 1 349,911 km<sup>2</sup> perdus suite aux arrondies

П27 ≡ pi vingt-sept

4 479 872 mm

П36

П38  
П39

П37

П34

П35

П32

П33

П30

П31

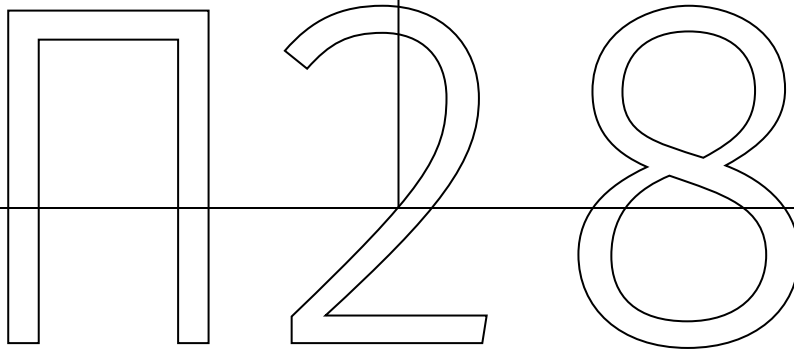

6 335 496 mm

П29

4 479 872 × 6 335 496 mm

268 435 456 par П0

≈ 1 349,911 km<sup>2</sup> perdus suite aux arrondies

П28 ≡ pi vingt-huit

3 167 748 mm

П37

П39  
П40

П38

П35

П36

П33

П34

П31

П32

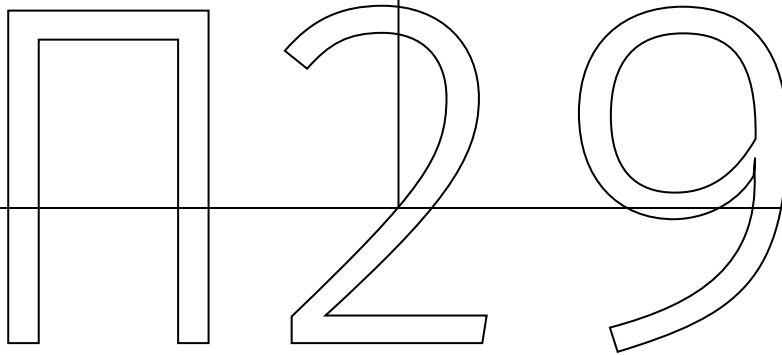

4 479 872 mm

П30

3 167 748 × 4 479 872 mm

536 870 912 par П0

≈ 1 349,911 km<sup>2</sup> perdus suite aux arrondies

П29 ≡ pi vingt-neuf



2 239 936 mm

П38



П36

П39

П37

П34

П35

П32

П33

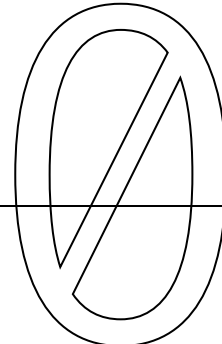
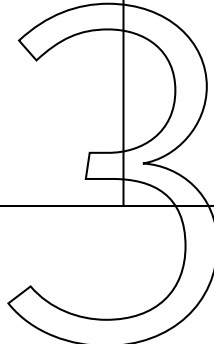
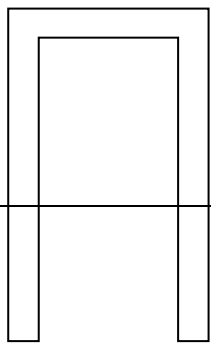

3 167 748 mm

П31

2 239 936 × 3 167 748 mm

1 073 741 824 par П0

≈ 1 349,911 km<sup>2</sup> perdus suite aux arrondies

П30 ≡ pi trente

1 583 874 mm

П39

П41  
П42

П40

П37

П38

П35

П36

П33

П34

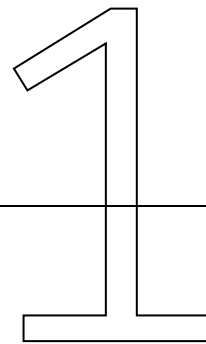
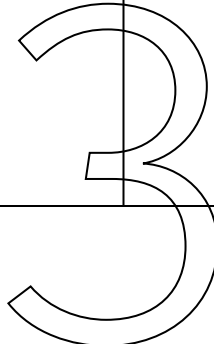
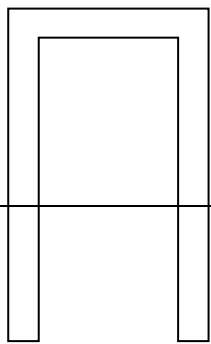

2 239 936 mm

П32

1 583 874 × 2 239 936 mm

2 147 483 648 par П0

≈ 1 349,911 km<sup>2</sup> perdus suite aux arrondies

П31 ≡ pi trente et un

1 119 968 mm

П40

П42  
П43

П41

П38

П39

П36

П37

П34

П35

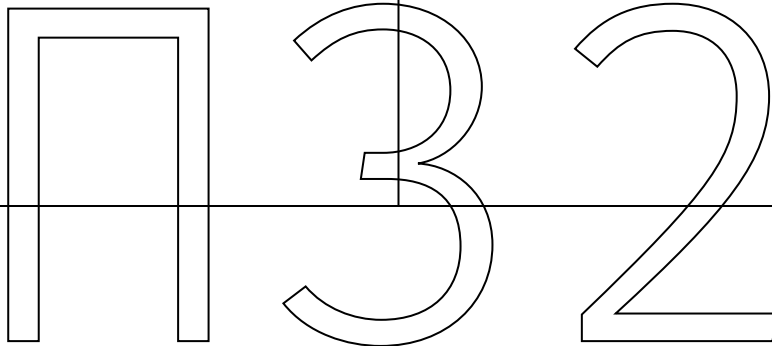

1 583 874 mm

П33

1 119 968 × 1 583 874 mm

4 294 967 296 par П0

≈ 1 349,911 km<sup>2</sup> perdus suite aux arrondies

П32 ≡ pi trente-deux

791 937 mm

П41

П43  
П44

П39

П42

П40

П37

П38

П35

П36

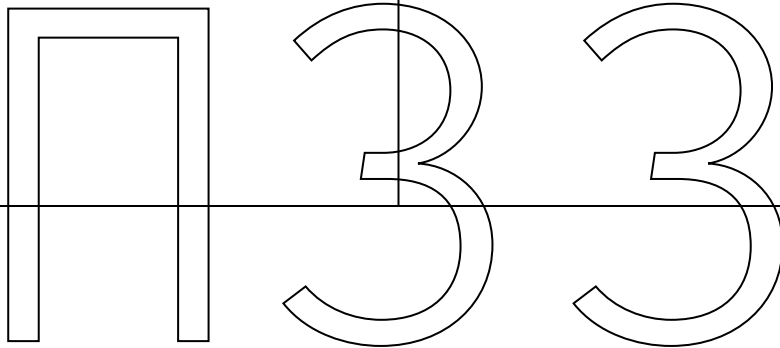

1 119 968 mm

П34

791 937 × 1 119 968 mm

8 589 934 592 par П0

≈ 1 349,911 km<sup>2</sup> perdus suite aux arrondies

П33 ≡ pi trente-trois

559 984 mm

П42

П44  
П45

П43

П40

П41

П38

П39

П36

П37

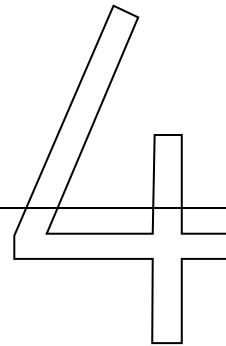
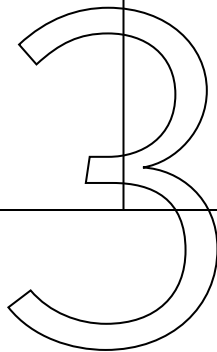
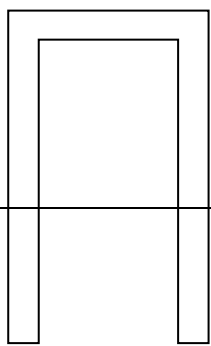

791 937 mm

П35

559 984 × 791 937 mm

17 179 869 184 par П0

≈ 1 349,911 km<sup>2</sup> perdus suite aux arrondies

П34 ≡ pi trente-quatre

395 968 mm

П43

П45

П46

П44

П41

П42

П39

П40

П37

П38

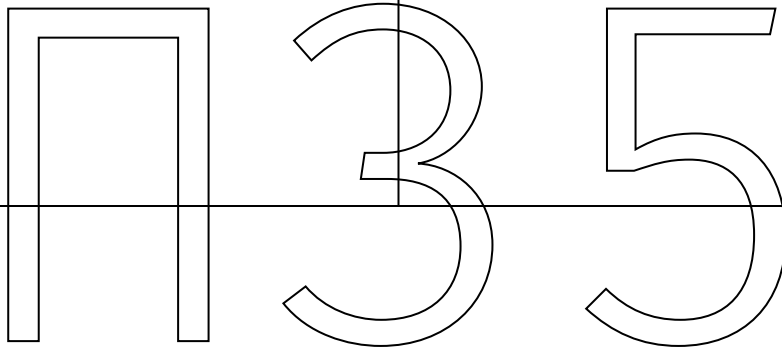

559 984 mm

П36

395 968 × 559 984 mm

34 359 738 368 par П0

≈ 10 970,363 km<sup>2</sup> perdus suite aux arrondies

П35 ≡ pi trente-cinq

279 992 mm

П44

П46  
П47

П45

П42

П43

П40

П41

П38

П39

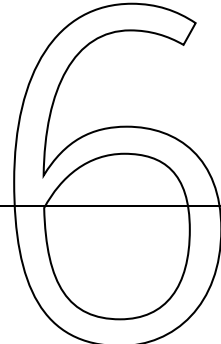
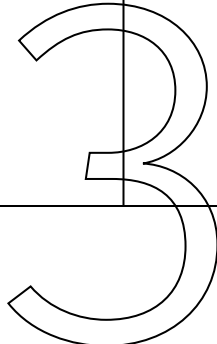
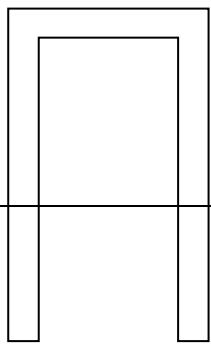

395 968 mm

П37

279 992 × 395 968 mm

68 719 476 736 par П0

≈ 10 970,363 km<sup>2</sup> perdus suite aux arrondies

П36 ≡ pi trente-six

197 984 mm

П45

П47

П48

П46

П43

П44

П41

П42

П39

П40

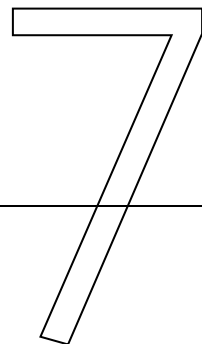
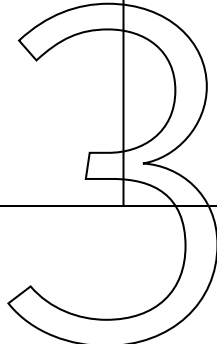
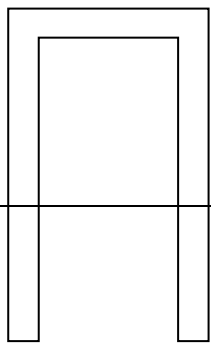

279 992 mm

П38

197 984 × 279 992 mm

137 438 953 472 par П0

≈ 10 970,363 km<sup>2</sup> perdus suite aux arrondies

П37 ≡ pi trente-sept



139 996 mm

П46

П48  
П49

П47

П44

П45

П42

П43

П40

П41

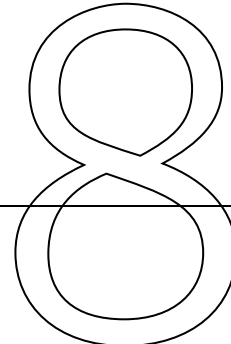
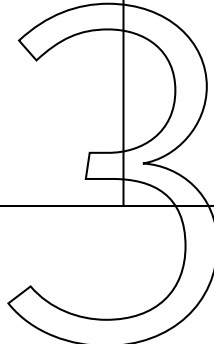
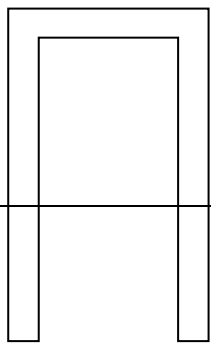

197 984 mm

П39

139 996 × 197 984 mm

274 877 906 944 par П0

≈ 10 970,363 km<sup>2</sup> perdus suite aux arrondies

П38 ≡ pi trente-huit

98 992 mm

П47

П49  
П50  
П48

П45

П46

П43

П44

П41

П42

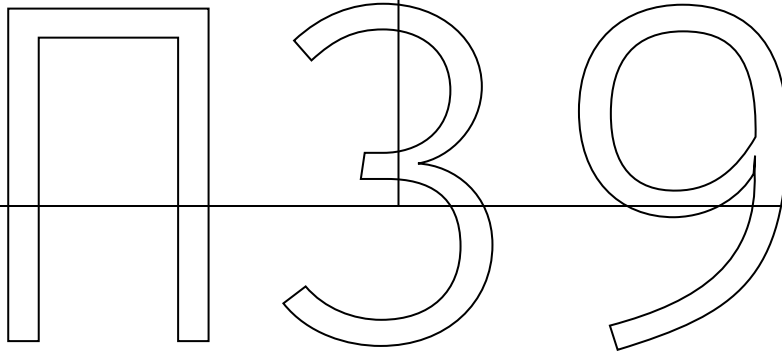

139 996 mm

П40

98 992 × 139 996 mm

549 755 813 888 par П0

≈ 10 970,363 km<sup>2</sup> perdus suite aux arrondies

П39 ≡ pi trente-neuf

π50  
π51

π48

π49

69 998 mm

π46

π47

π44

π45

π42

π43

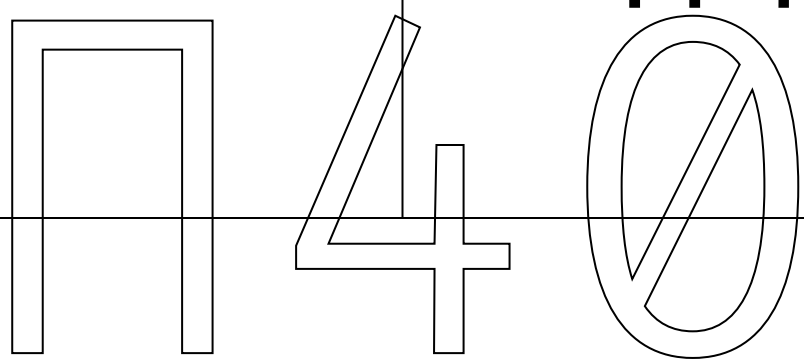

98 992 mm

π41

69 998 × 98 992 mm

1 099 511 627 776 par π0

≈ 10 970,363 km<sup>2</sup> perdus suite aux arrondies

π40 ≡ pi quarante

π51	π52
π49	π50

49 496 mm

π47

π48

π45

π46

π43

π44

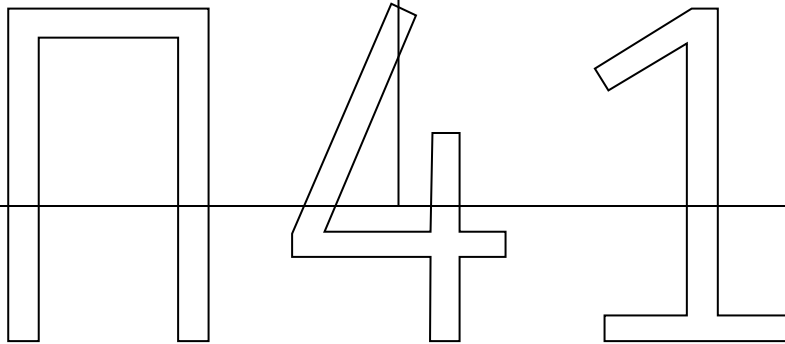

69 998 mm

π42

49 496 × 69 998 mm

2 199 023 255 552 par π0

≈ 10 970,363 km<sup>2</sup> perdus suite aux arrondies

π41 ≡ pi quarante et un

п50  
п51  
п52  
п53

34 999 mm

П48

П49

П46

П47

П44

П45

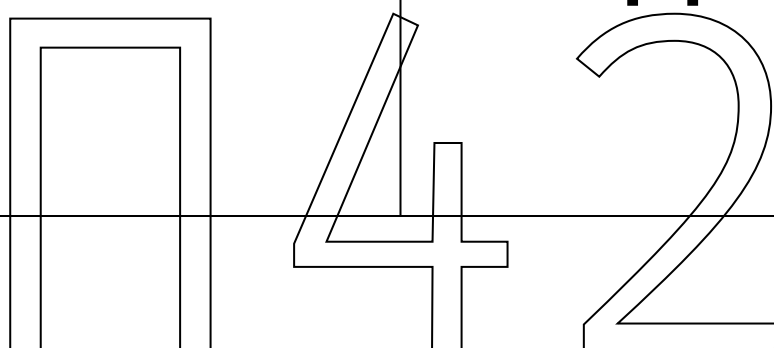

49 496 mm

П43

34 999 × 49 496 mm

4 398 046 511 104 par П0

≈ 10 970,363 km<sup>2</sup> perdus suite aux arrondies

П42 ≡ pi quarante-deux

п51  
п52  
п53  
п54

24 748 mm

п49

п50

п47

п48

п45

п46

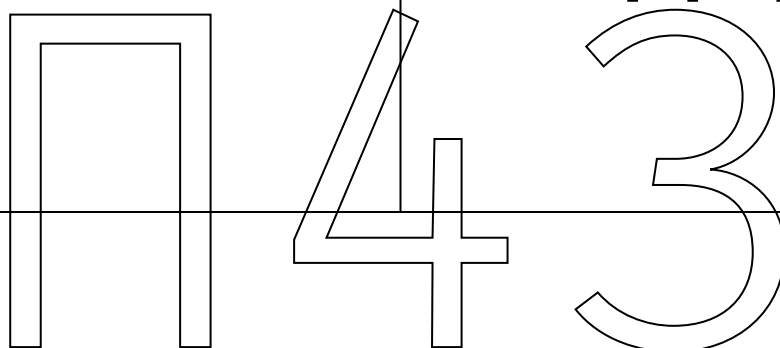

34 999 mm

п44

24 748 × 34 999 mm

8 796 093 022 208 par П0

≈ 10 970,363 km<sup>2</sup> perdus suite aux arrondies

п43 ≡ pi quarante-trois

π54	π55
π52	π53

17 499 mm

π50

π51

π48

π49

π46

π47

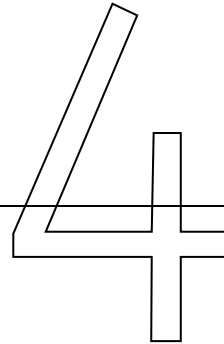
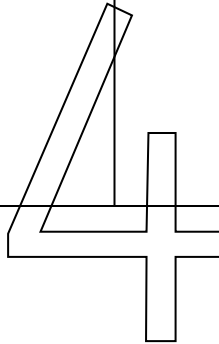
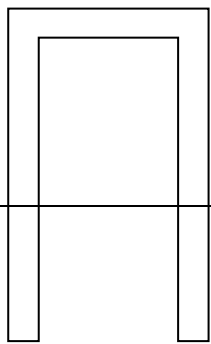

24 748 mm

π45

17 499 × 24 748 mm

17 592 186 044 416 par π0

≈ 228 656,073 km<sup>2</sup> perdus suite aux arrondies

π44 ≡ pi quarante-quatre

π55  
π56

π53

π54

12 374 mm

π51

π52

π49

π50

π47

π48

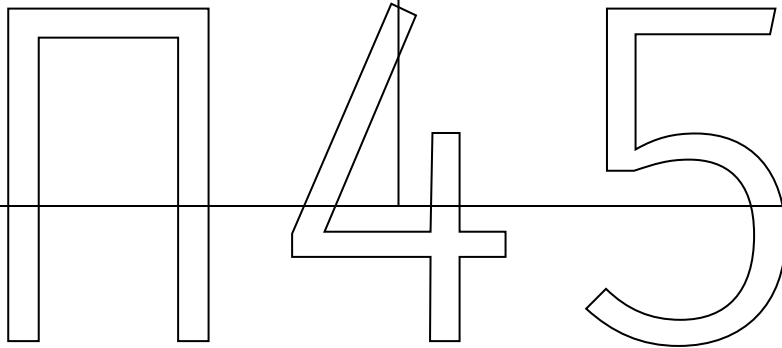

17 499 mm

π46

12 374 × 17 499 mm

35 184 372 088 832 par π0

≈ 228 656,073 km<sup>2</sup> perdus suite aux arrondies

π45 ≡ pi quarante-cinq





П54

П56

П57

П55

П52

П53

8 749 mm

П50

П51

П48

П49

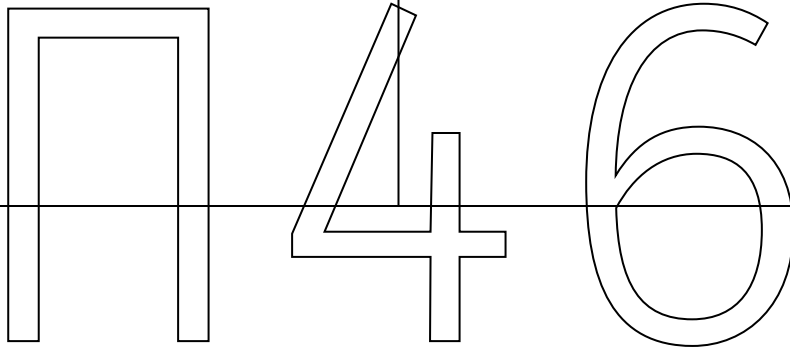

12 374 mm

П47

8 749 × 12 374 mm

70 368 744 177 664 par П0

≈ 664 027,494 km<sup>2</sup> perdus suite aux arrondies

П46 ≡ pi quarante-six

П49

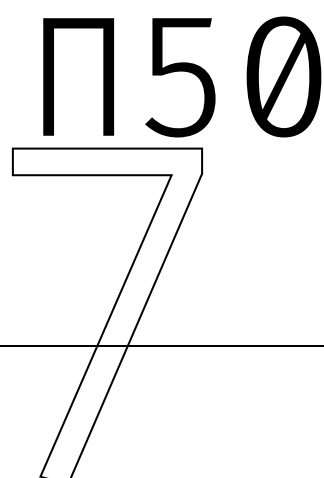
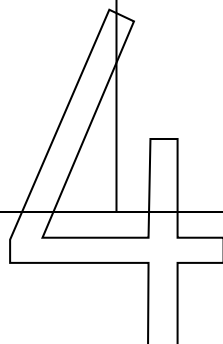
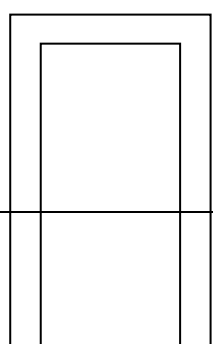

6 187 mm

П51

П53

П52

П55

П57  
П58  
П56

П54

8 749 mm

П48

6 187 × 8 749 mm

140 737 488 355 328 par П0

≈ 664 027,494 km<sup>2</sup> perdus suite aux arrondies

П47 ≡ pi quarante-sept

П50

4 374 mm

П52

П54

П56

П58

П59

П57

П55

П53

П51

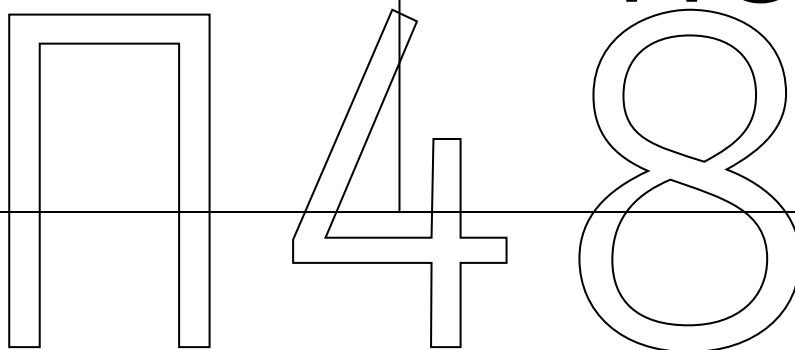

6 187 mm

П49

4 374 × 6 187 mm

281 474 976 710 656 par П0

≈ 1 534 770,334 km<sup>2</sup> perdus suite aux arrondies

П48 ≡ pi quarante-huit

π59  
π60

π57

π58

3 093 mm

π55

π56

π53

π54

π51

π52

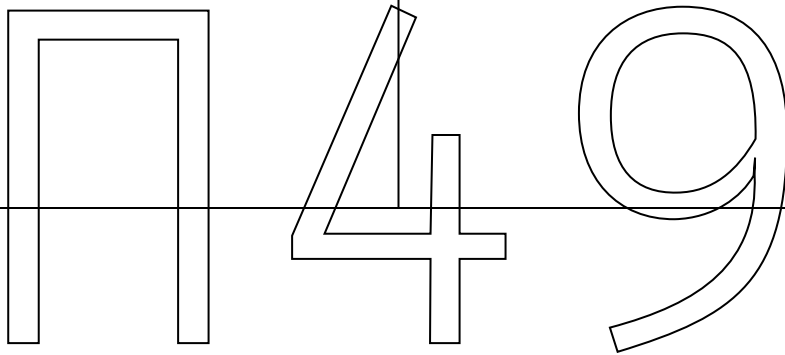

4 374 mm

π50

3 093 × 4 374 mm

562 949 953 421 312 par π0

≈ 2 765 941,882 km<sup>2</sup> perdus suite aux arrondies

π49 ≡ pi quarante-neuf

П52

2 187 mm

П54

П56

П58

П60

П59

П57

П55

П53

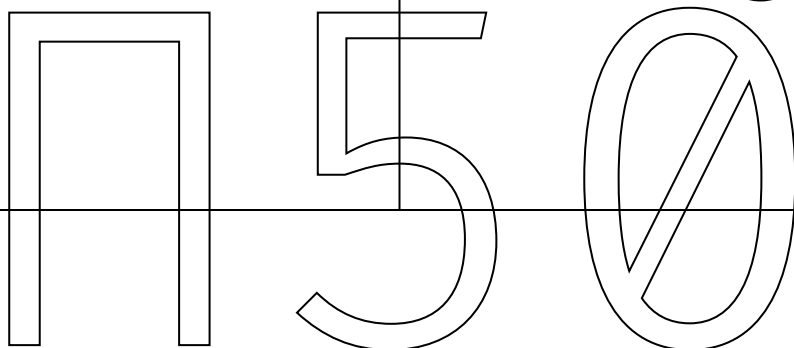

3 093 mm

П51

2 187 × 3 093 mm

1 125 899 906 842 624 par П0

≈ 2 765 941,882 km<sup>2</sup> perdus suite aux arrondies

П50 ≡ pi cinquante

П53

1 546 mm

П55

П57

П59

П61

П62

П60

П58

П56

П54

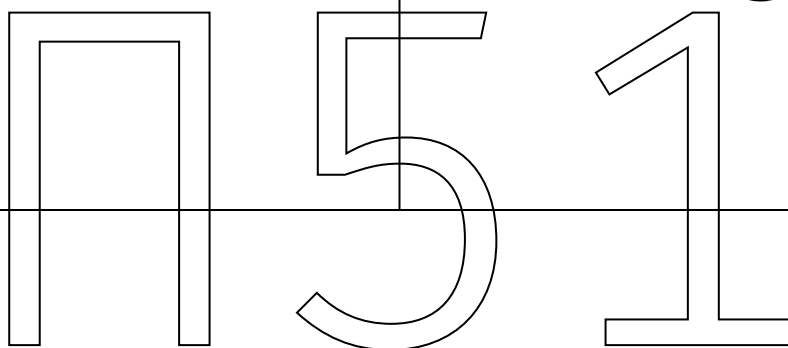

2 187 mm

П52

1 546 × 2 187 mm

2 251 799 813 685 248 par П0

≈ 5 228 284,978 km<sup>2</sup> perdus suite aux arrondies

П51 ≡ pi cinquante et un

П54

1 093 mm

П56

П58

П60

П62

П63

П61

П59

П57

П55

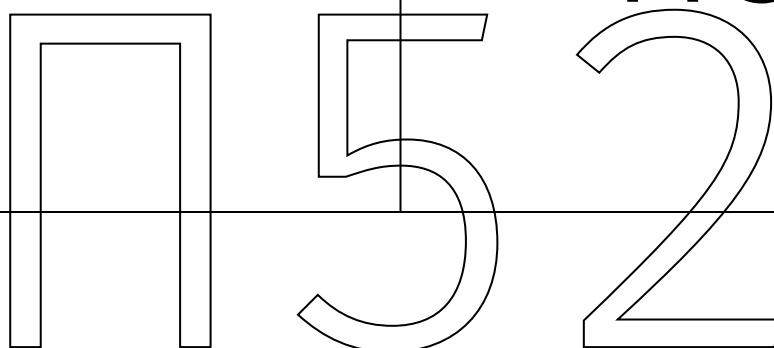

1 546 mm

П53

1 093 × 1 546 mm

4 503 599 627 370 496 par П0

≈ 8 709 567,49 km<sup>2</sup> perdus suite aux arrondies

П52 ≡ pi cinquante-deux

П55

773 mm

П57

П59

П61

П63

П62

П60

П58

П56

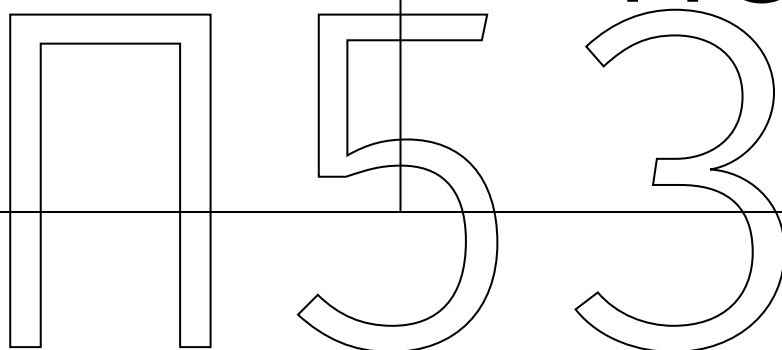

1 093 mm

П54

773 × 1 093 mm

9 007 199 254 740 992 par П0

≈ 8 709 567,49 km<sup>2</sup> perdus suite aux arrondies

П53 ≡ pi cinquante-trois



П56

546 mm

П58

П60

П62

П63

П61

П59

П57

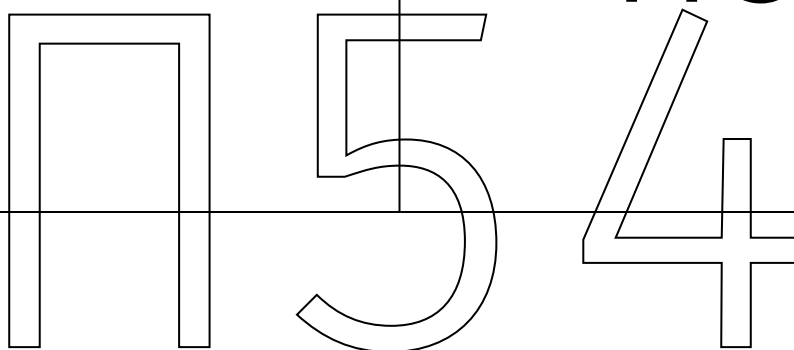

773 mm

П55

546 × 773 mm

18 014 398 509 481 984 par П0

≈ 15 672 132,514 km<sup>2</sup> perdus suite aux arrondies

П54 ≡ pi cinquante-quatre

П57

386 mm

П59

П61

П63

П62

П60

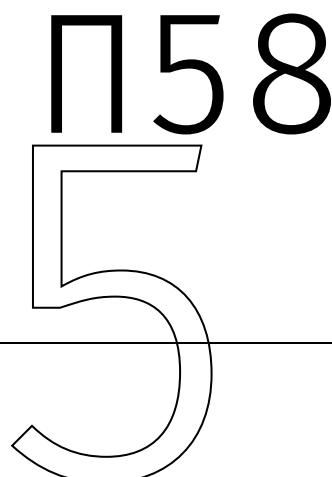
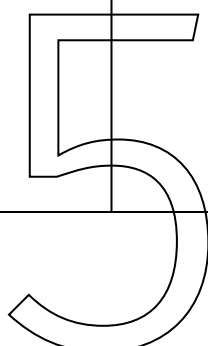
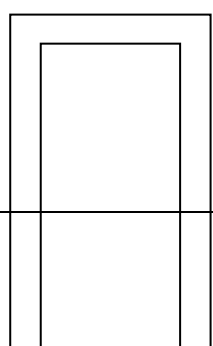

546 mm

П56

386 × 546 mm

36 028 797 018 963 968 par П0

≈ 25 507 994,1 km<sup>2</sup> perdus suite aux arrondies

П55 ≡ pi cinquante-cinq

273 mm

П62

П63

П60

П61

П58

П59

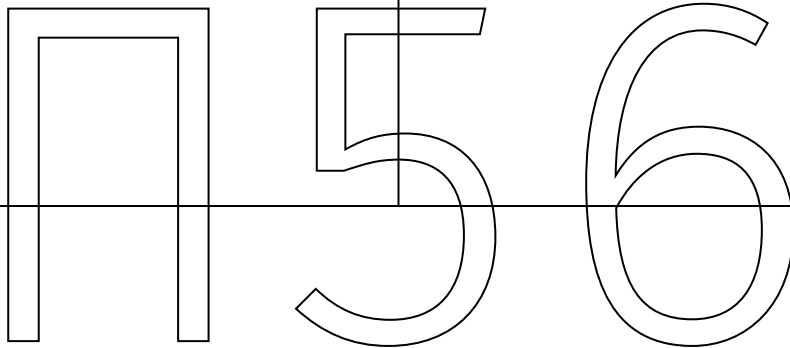

386 mm

П57

273 × 386 mm

72 057 594 037 927 936 par П0

≈ 25 507 994,1 km<sup>2</sup> perdus suite aux arrondies

П56 ≡ pi cinquante-six

193 mm

П63

П61

П62

П59

П60

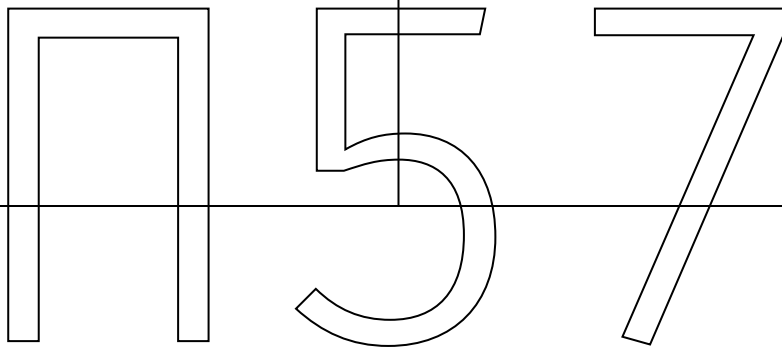

273 mm

П58

193 × 273 mm

144 115 188 075 855 872 par П0

≈ 25 507 994,1 km<sup>2</sup> perdus suite aux arrondies

П57 ≡ pi cinquante-sept

136 mm

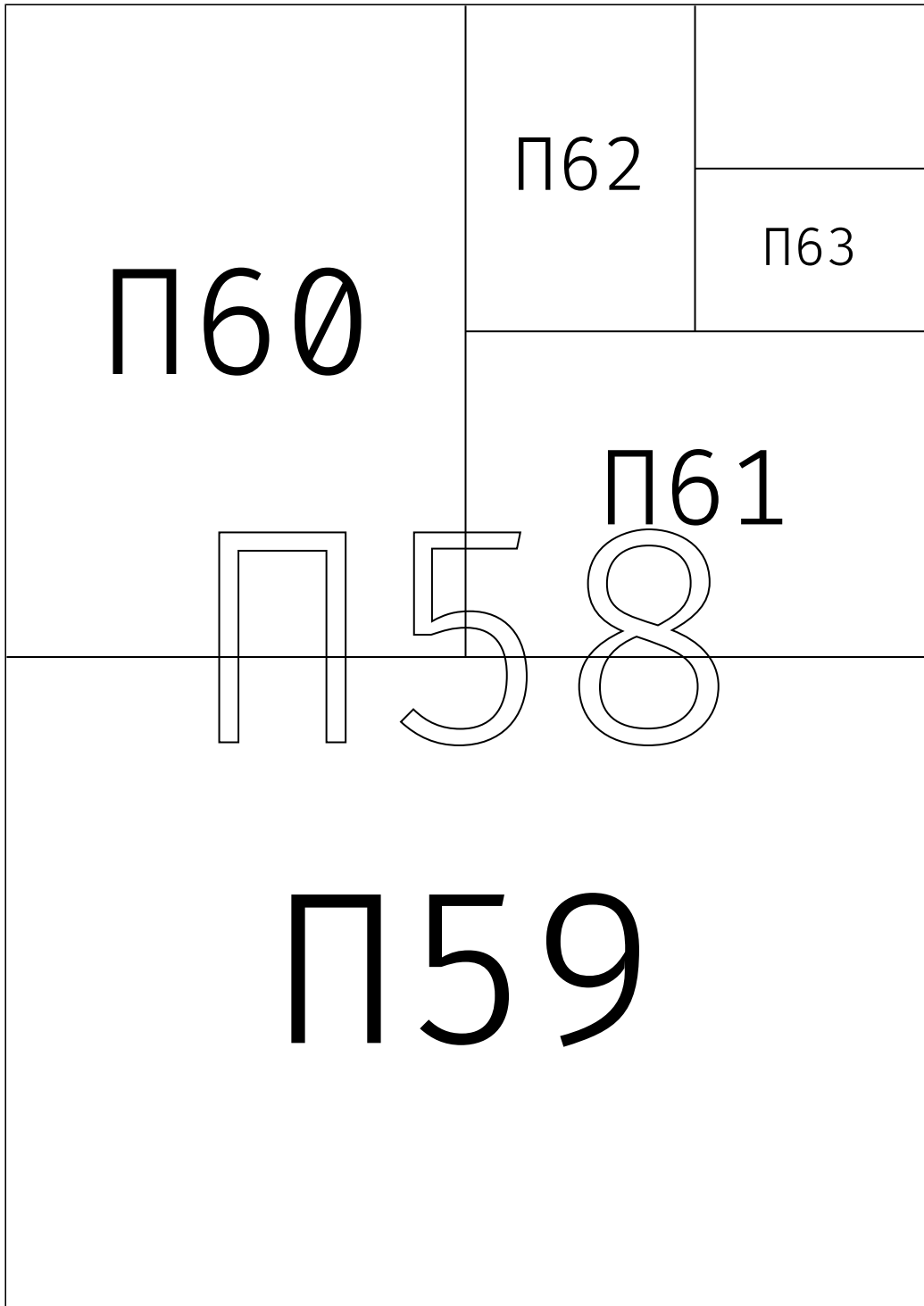

193 mm

136 × 193 mm

288 230 376 151 711 744 par П0

≈ 53 322 225,399 km<sup>2</sup> perdus suite aux arrondies

П58 ≡ pi cinquante-huit

96 mm

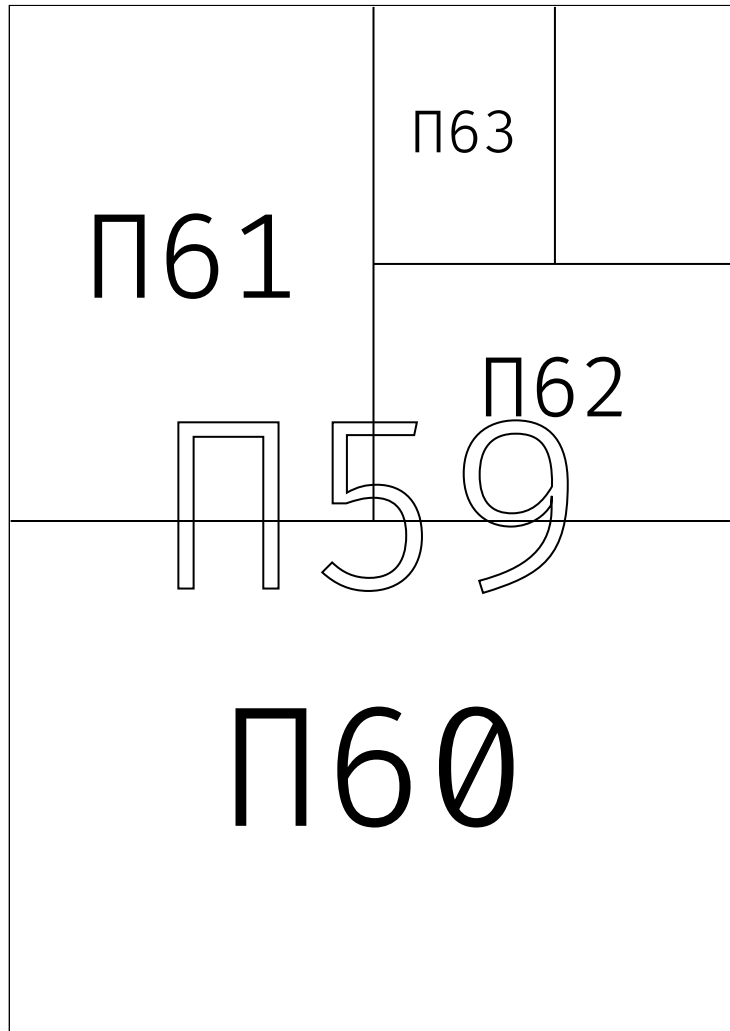

136 mm

96 × 136 mm

576 460 752 303 423 488 par П0

≈ 92 521 556,556 km<sup>2</sup> perdus suite aux arrondies

П59 ≡ pi cinquante-neuf

68 mm

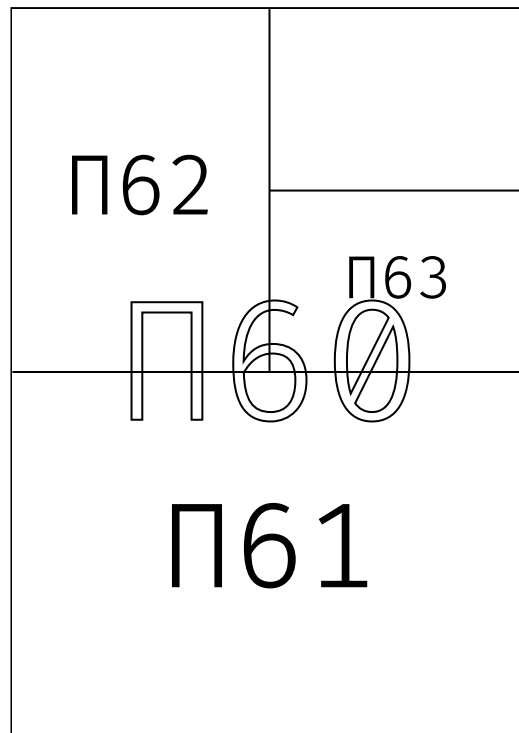

96 mm

68 × 96 mm

1 152 921 504 606 846 976 par П0

≈ 92 521 556,556 km<sup>2</sup> perdus suite aux arrondies

П60 ≡ pi soixante

48 mm

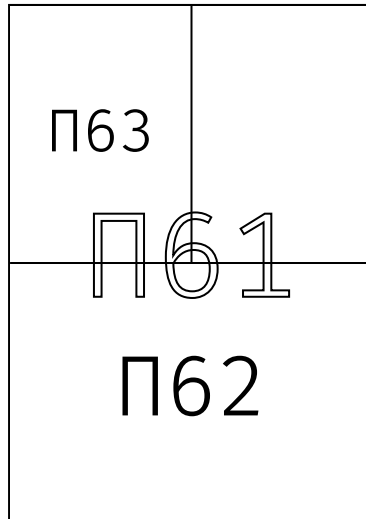

68 mm

48 × 68 mm

2 305 843 009 213 693 952 par П0

≈ 92 521 556,556 km<sup>2</sup> perdus suite aux arrondies

П61 ≡ pi soixante et un



34 mm



48 mm

34 × 48 mm

4 611 686 018 427 387 904 par Π0

≈ 92 521 556,556 km<sup>2</sup> perdus suite aux arrondies

Π62 ≡ pi soixante-deux

24 mm

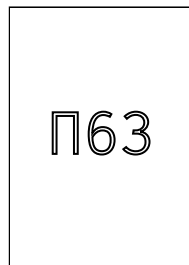

34 mm

24 × 34 mm

9 223 372 036 854 775 808 par П0

≈ 92 521 556,556 km<sup>2</sup> perdus suite aux arrondies

П63 ≡ pi soixante-trois