

$\Pi_0 = \text{area of Neptune} \pm 1 \text{ mm}$

$\Pi_0 \rightarrow \Pi_{63}$

73,398.230,855,942,92 km

π (pi)  
0-63

# NEPTUNE

103,800.773,530,665,89 km

equatorial radius : 24,764 km  
polar radius : 24,341 km

calculated area : 7,618,793,138.629,264 km<sup>2</sup>  
rectangle with an area equal to Neptune and a ratio of  
1:√2 :

width : 73,398.230,855,942,92 km  
height : 103,800.773,530,665,89 km

This series is printed in the format α57 (193 × 273 mm), the  
first format that can be affixed on an A4 format.

73,398,230,855 mm

П8

П10

П11

П9

П6

П7

П4

П5

П2

П3

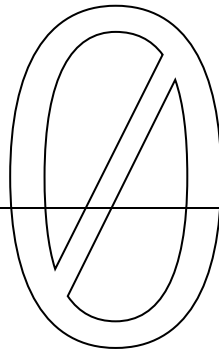
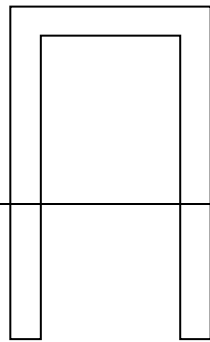

103,800,773,530 mm

П1

73,398,230,855 × 103,800,773,530 mm

1 per П0

≈ 0.147 km² lost due to rounding

П0 ≡ pi zero

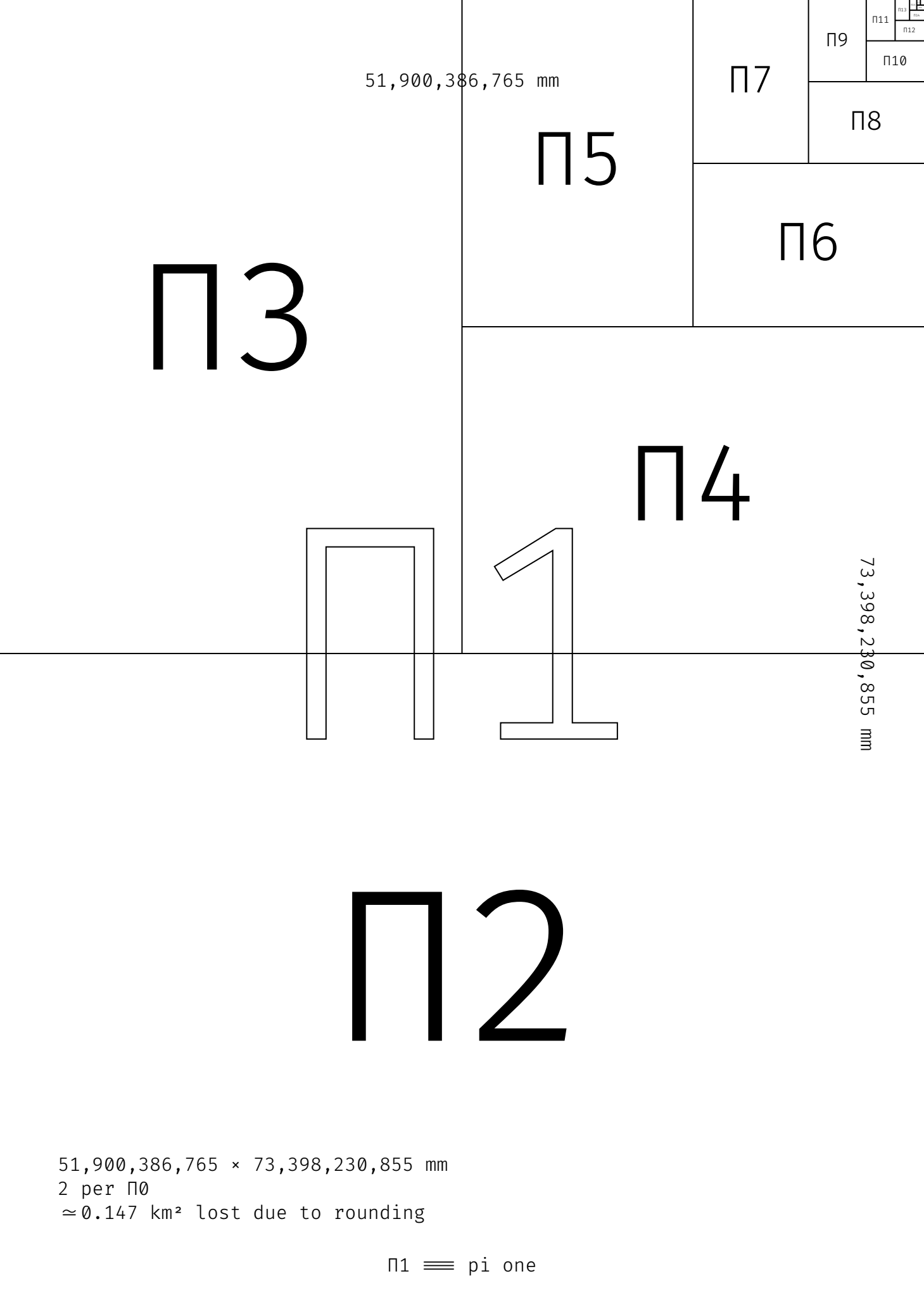

51,900,386,765 mm

П3

П5

П7

П9

П11  
П12  
П10

П8

П6

П4

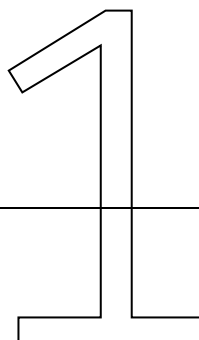
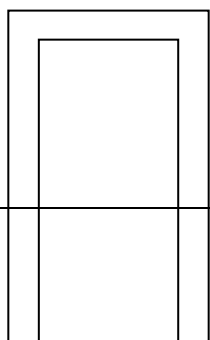

73,398,230,855 mm

П2

51,900,386,765 × 73,398,230,855 mm  
 2 per П0  
 ≈ 0.147 km² lost due to rounding

П1 ≡ pi one

36,699,115,427 mm

π10

π12  
π13

π11

π8

π9

π6

π7

π4

π5

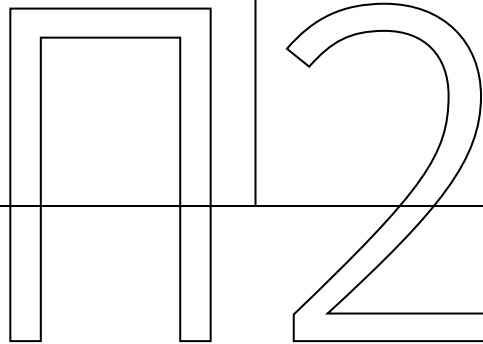

51,900,386,765 mm

π3

36,699,115,427 × 51,900,386,765 mm

4 per π0

≈ 0.251 km² lost due to rounding

π2 ≡ pi two

25,950,193,382 mm

π11



π9

π10

π7

π8

π5

π6

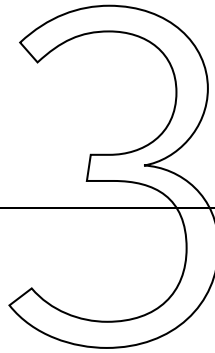
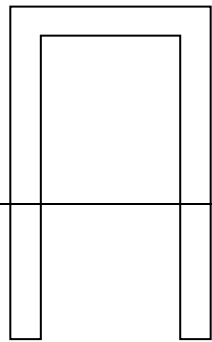

36,699,115,427 mm

π4

25,950,193,382 × 36,699,115,427 mm

8 per π0

≈ 0.397 km² lost due to rounding

π3 ≡ pi three

18,349,557,713 mm

Π12

Π14  
Π15

Π13

Π10

Π11

Π8

Π9

Π6

Π7

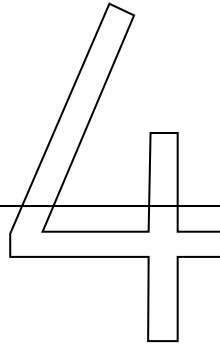
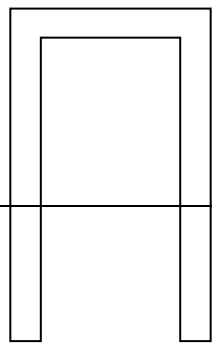

25,950,193,382 mm

Π5

18,349,557,713 × 25,950,193,382 mm  
16 per Π0  
≈ 0.605 km<sup>2</sup> lost due to rounding

Π4 ≡ pi four

12,975,096,691 mm

Π13

Π15  
Π16  
Π14

Π11

Π12

Π9

Π10

Π7

Π8

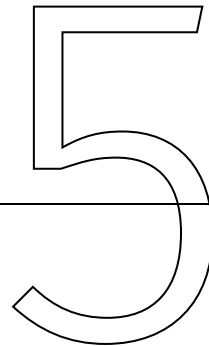
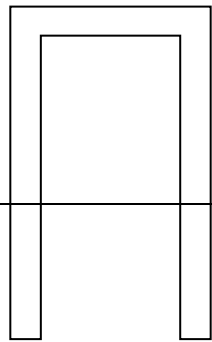

18,349,557,713 mm

Π6

12,975,096,691 × 18,349,557,713 mm

32 per Π0

≈ 0.605 km<sup>2</sup> lost due to rounding

Π5 ≡ pi five



9,174,778,856 mm

π14

π16  
π17  
π15

π12

π13

π10

π11

π8

π9

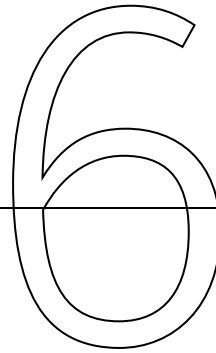
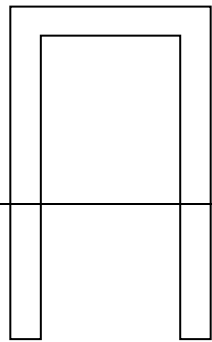

12,975,096,691 mm

π7

9,174,778,856 × 12,975,096,691 mm

64 per π0

≈ 1.02 km<sup>2</sup> lost due to rounding

π6 ≡ pi six

6,487,548,345 mm

π15

π17  
π18

π13

π16

π14

π11

π12

π9

π10

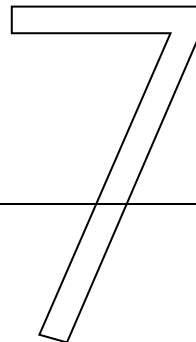
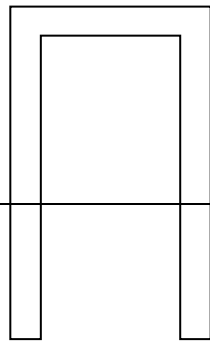

9,174,778,856 mm

π8

6,487,548,345 × 9,174,778,856 mm  
128 per π0  
≈1.607 km<sup>2</sup> lost due to rounding

π7 ≡ pi seven

4,587,389,428 mm

π16

π18

π19

π17

π14

π15

π12

π13

π10

π11

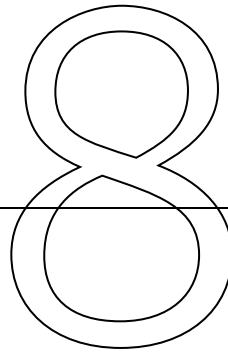
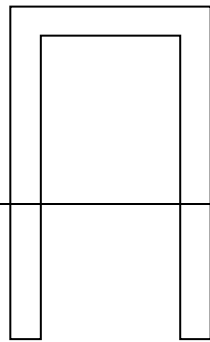

6,487,548,345 mm

π9

4,587,389,428 × 6,487,548,345 mm

256 per π0

≈1.607 km² lost due to rounding

π8 ≡ pi eight

3,243,774,172 mm

π17

π19  
π20

π18

π15

π16

π13

π14

π11

π12

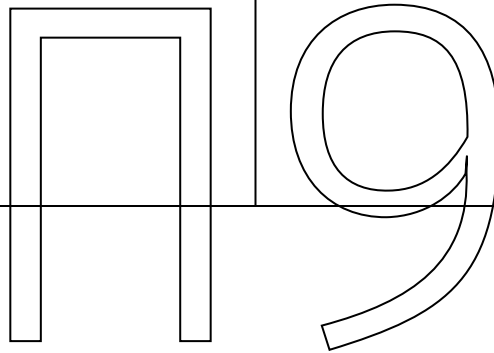

4,587,389,428 mm

π10

3,243,774,172 × 4,587,389,428 mm

512 per π0

≈ 2.782 km² lost due to rounding

π9 ≡ pi nine



П18

П20  
П21

П19

П16

П17

2,293,694,714 mm

П14

П15

П12

П13

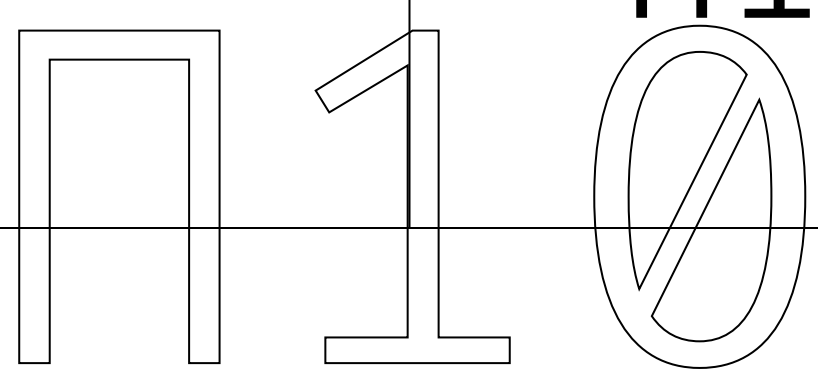

3,243,774,172 mm

П111

2,293,694,714 × 3,243,774,172 mm  
1,024 per П0  
≈ 2.782 km² lost due to rounding

П10 ≡ pi ten

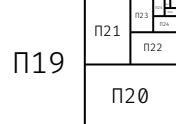

1,621,887,086 mm

π17

π19

π21

π22

π20

π18

π15

π16

π13

π14

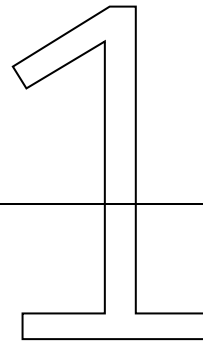
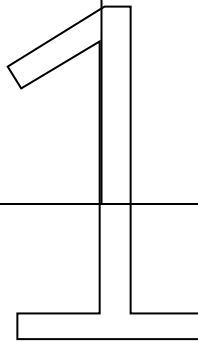
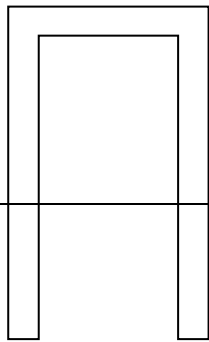

2,293,694,714 mm

π12

1,621,887,086 × 2,293,694,714 mm  
 2,048 per π0  
 ≈ 2.782 km² lost due to rounding

π11 ≡ pi eleven

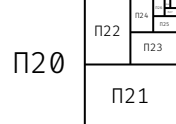

1,146,847,357 mm

π18

π19

π16

π17

π14

π15

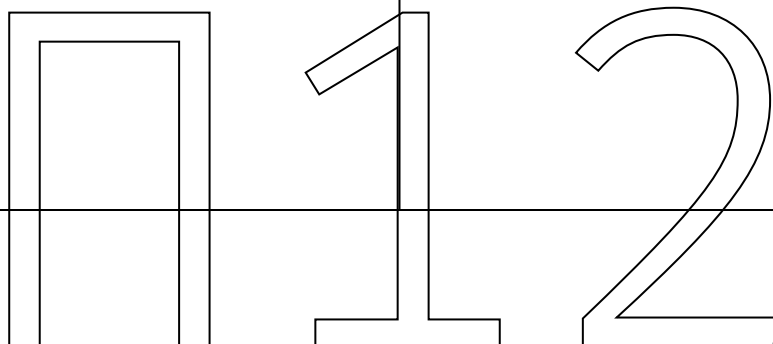

1,621,887,086 mm

π13

1,146,847,357 × 1,621,887,086 mm  
 4,096 per π0  
 ≈ 2.782 km<sup>2</sup> lost due to rounding

π12 ≡ pi twelve

810,943,543 mm

П21

П23

П24

П22

П19

П20

П17

П18

П15

П16

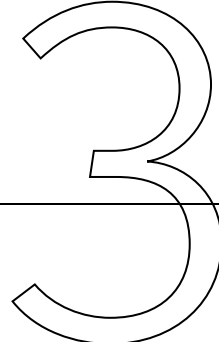
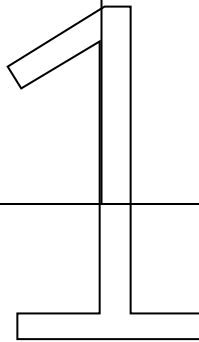
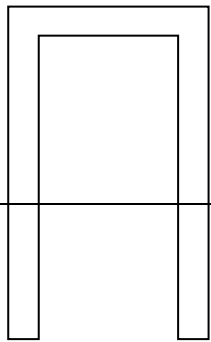

1,146,847,357 mm

П14

810,943,543 × 1,146,847,357 mm

8,192 per П0

≈ 2.782 km² lost due to rounding

П13 ≡ pi thirteen



573,423,678 mm

П22

П24  
П25

П23

П20

П21

П18

П19

П16

П17

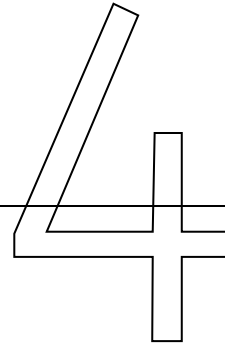
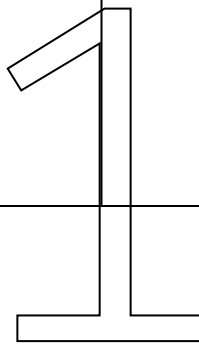
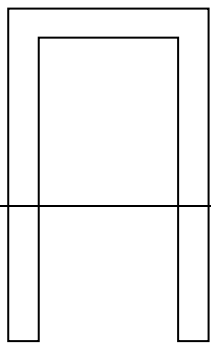

810,943,543 mm

П15

573,423,678 × 810,943,543 mm

16,384 per П0

≈ 9.425 km² lost due to rounding

П14 ≡ pi fourteen



п23

п25  
п26

п24

405,471,771 mm

п21

п22

п19

п20

п17

п18

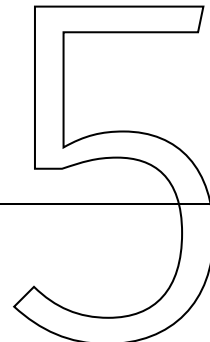
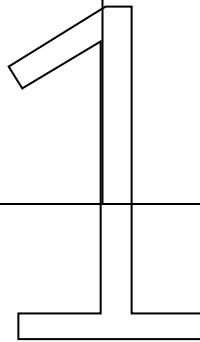
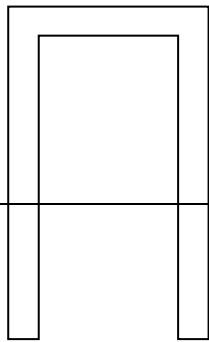

573,423,678 mm

п16

405,471,771 × 573,423,678 mm

32,768 per п0

≈ 18.82 km<sup>2</sup> lost due to rounding

п15 ≡ pi fifteen

286,711,839 mm

П24

П26  
П27  
П25

П22

П23

П20

П21

П18

П19

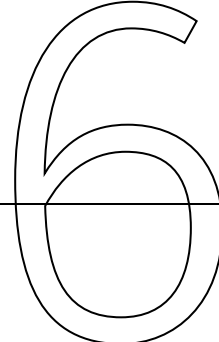
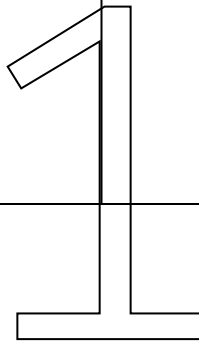
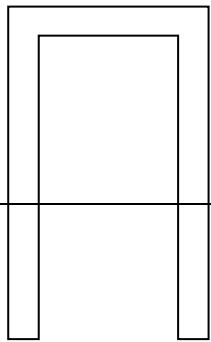

405,471,771 mm

П17

286,711,839 × 405,471,771 mm

65,536 per П0

≈ 18.82 km² lost due to rounding

П16 ≡ pi sixteen

202,735,885 mm

π25

π27

π28

π26

π23

π24

π21

π22

π19

π20

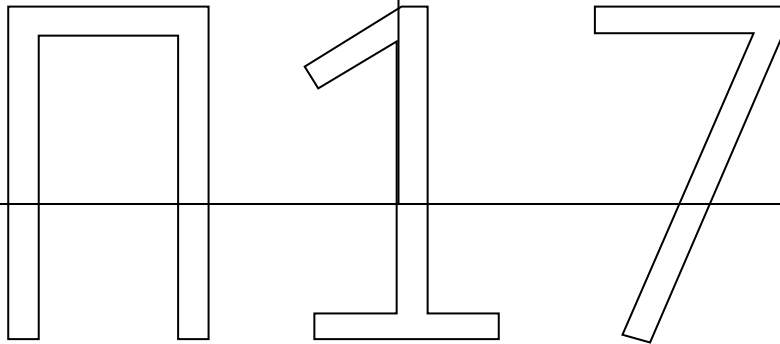

286,711,839 mm

π18

202,735,885 × 286,711,839 mm  
 131,072 per π0  
 ≈ 37.61 km<sup>2</sup> lost due to rounding

π17 ≡ pi seventeen

143,355,919 mm

π26

π28  
π29

π27

π24

π25

π22

π23

π20

π21

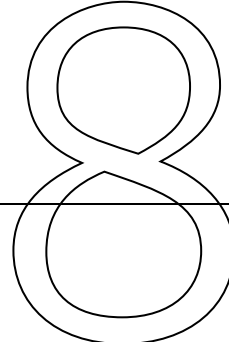
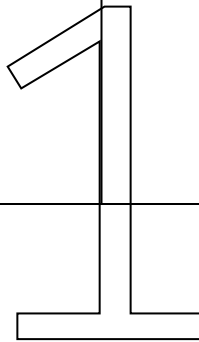
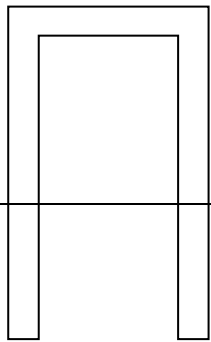

202,735,885 mm

π19

143,355,919 × 202,735,885 mm

262,144 per π0

≈ 64.183 km² lost due to rounding

π18 ≡ pi eighteen

101,367,942 mm

π27



π25

π26

π23

π24

π21

π22

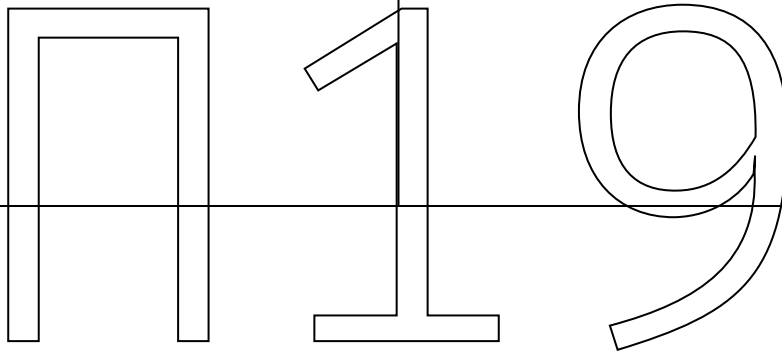

143,355,919 mm

π20

101,367,942 × 143,355,919 mm

524,288 per π0

≈ 101.763 km<sup>2</sup> lost due to rounding

π19 ≡ pi nineteen

71,677,959 mm

π28

π30  
π31

π29

π26

π27

π24

π25

π22

π23

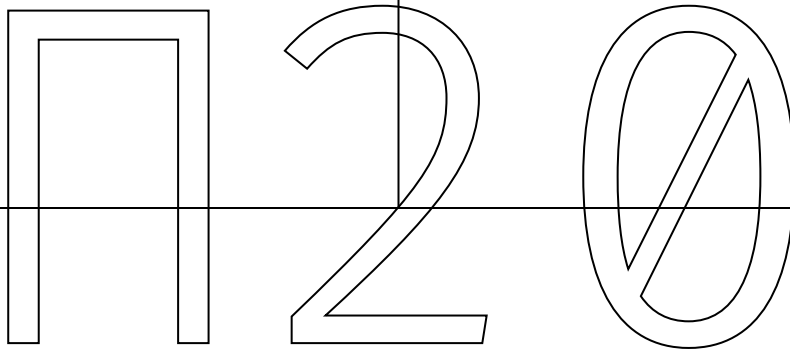

101,367,942 mm

π21

71,677,959 × 101,367,942 mm

1,048,576 per π0

≈ 154.909 km<sup>2</sup> lost due to rounding

π20 ≡ pi twenty

50,683,971 mm

π29

π31  
π32  
π30

π27

π28

π25

π26

π23

π24

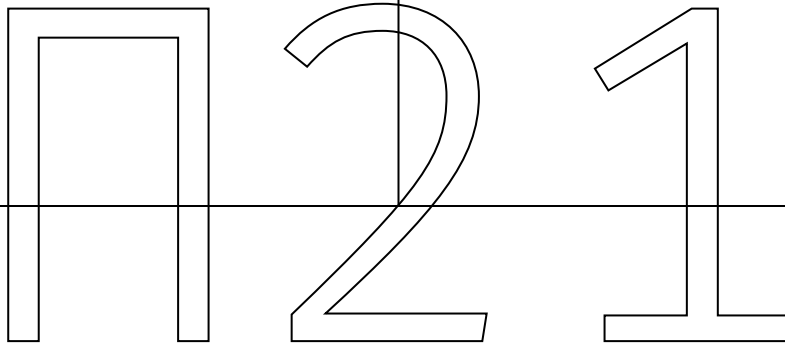

71,677,959 mm

π22

50,683,971 × 71,677,959 mm

2,097,152 per π0

≈ 154.909 km² lost due to rounding

π21 ≡ pi twenty-one



35,838,979 mm

П30

П32  
П33  
П31

П28

П29

П26

П27

П24

П25

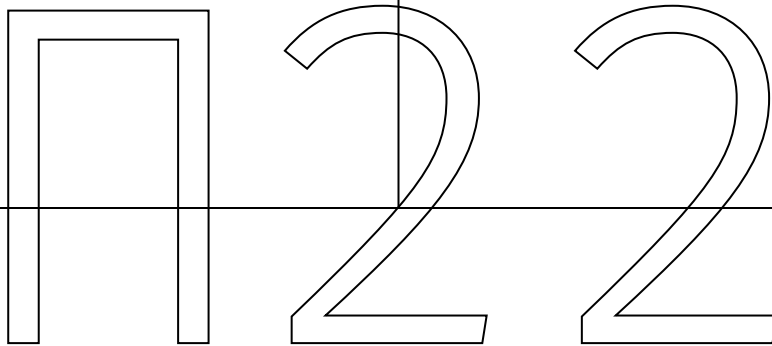

50,683,971 mm

П23

35,838,979 × 50,683,971 mm

4,194,304 per П0

≈ 261.201 km<sup>2</sup> lost due to rounding

П22 ≡ pi twenty-two

25,341,985 mm

π31



π29

π30

π27

π28

π25

π26

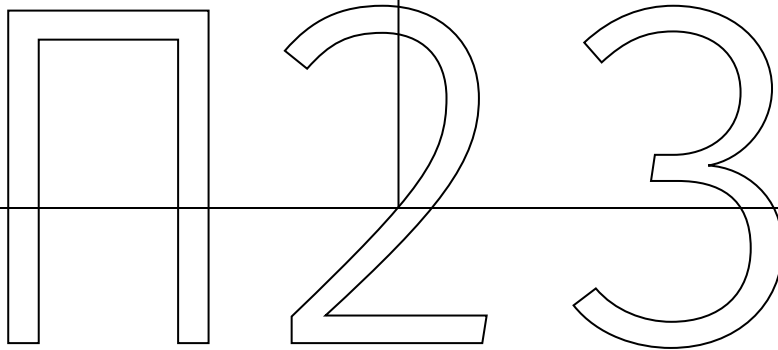

35,838,979 mm

π24

25,341,985 × 35,838,979 mm

8,388,608 per π0

≈411.52 km² lost due to rounding

π23 ≡ pi twenty-three

17,919,489 mm

П32

П34  
П35

П33

П30

П31

П28

П29

П26

П27

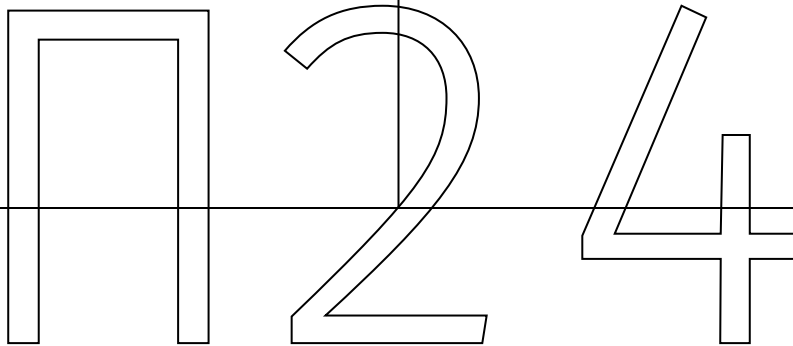

25,341,985 mm

П25

17,919,489 × 25,341,985 mm

16,777,216 per П0

≈ 624.104 km<sup>2</sup> lost due to rounding

П24 ≡ pi twenty-four

12,670,992 mm

π33



π31

π34

π32

π29

π30

π27

π28

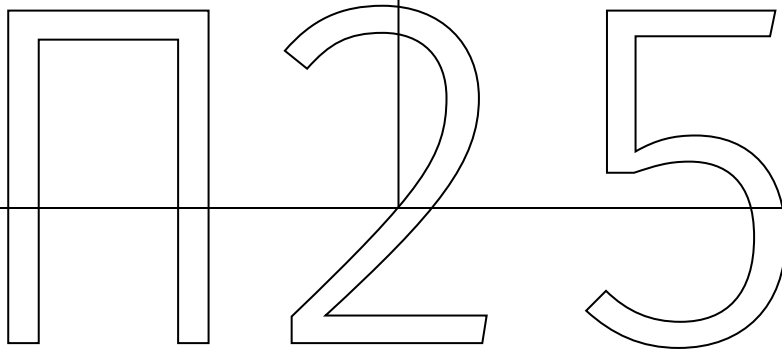

17,919,489 mm

π26

$12,670,992 \times 17,919,489$  mm  
 33,554,432 per π0  
 $\approx 924.743$  km<sup>2</sup> lost due to rounding

π25 ≡ pi twenty-five

П28

8,959,744 mm

П30

П32

П34

П36

П37

П35

П33

П31

П29

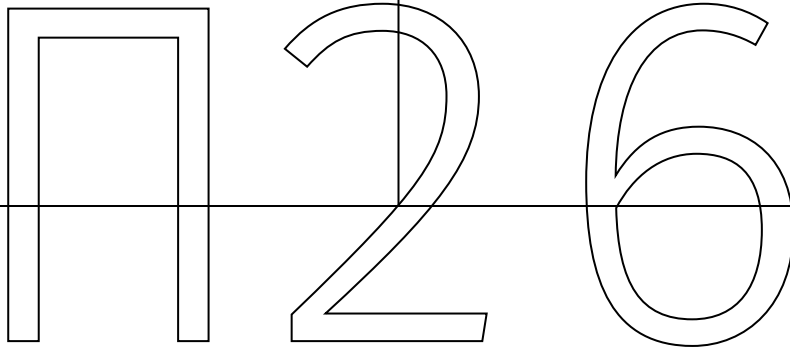

12,670,992 mm

П27

8,959,744 × 12,670,992 mm

67,108,864 per П0

≈ 1,349.911 km<sup>2</sup> lost due to rounding

П26 ≡ pi twenty-six

6,335,496 mm

π35



π33

π34

π31

π32

π29

π30

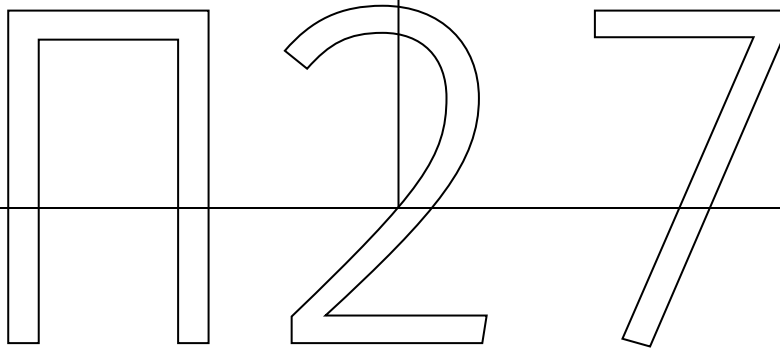

8,959,744 mm

π28

6,335,496 × 8,959,744 mm

134,217,728 per π0

≈ 1,349.911 km<sup>2</sup> lost due to rounding

π27 ≡ pi twenty-seven



3,167,748 mm

П37

П39

П40

П38

П35

П36

П33

П34

П31

П32

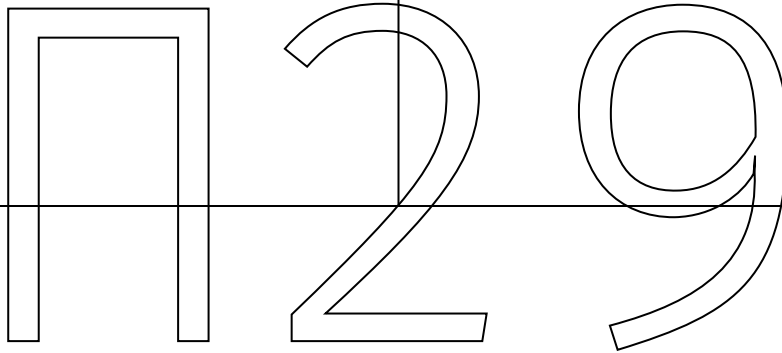

4,479,872 mm

П30

3,167,748 × 4,479,872 mm

536,870,912 per П0

≈ 1,349.911 km<sup>2</sup> lost due to rounding

П29 ≡ pi twenty-nine



2,239,936 mm

П38



П36

П37

П34

П35

П32

П33

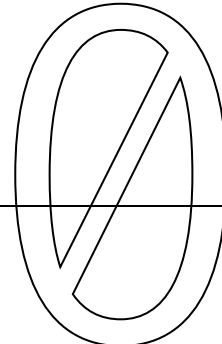
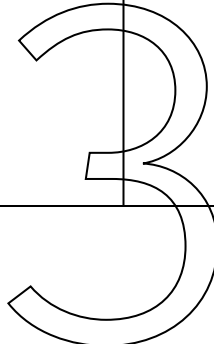
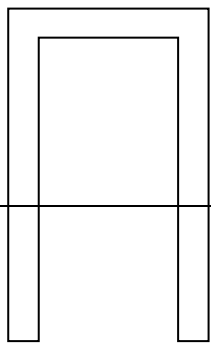

3,167,748 mm

П31

2,239,936 × 3,167,748 mm

1,073,741,824 per П0

≈ 1,349.911 km<sup>2</sup> lost due to rounding

П30 ≡ pi thirty

П39  
П40  
П41  
П42

1,583,874 mm

П37

П38

П35

П36

П33

П34

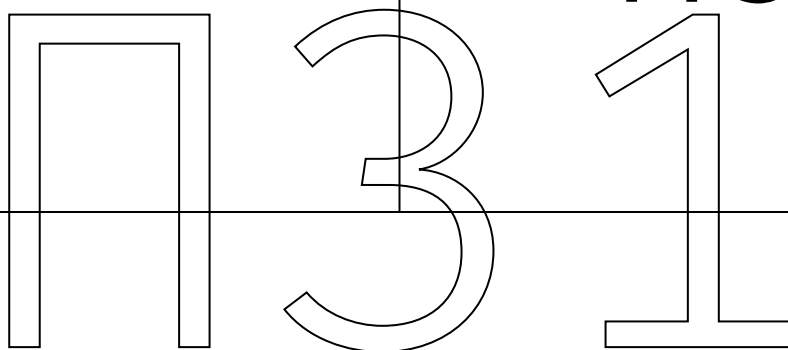

2,239,936 mm

П32

1,583,874 × 2,239,936 mm

2,147,483,648 per П0

≈ 1,349.911 km<sup>2</sup> lost due to rounding

П31 ≡ pi thirty-one

П40  
П41  
П42  
П43

1,119,968 mm

П38

П39

П36

П37

П34

П35

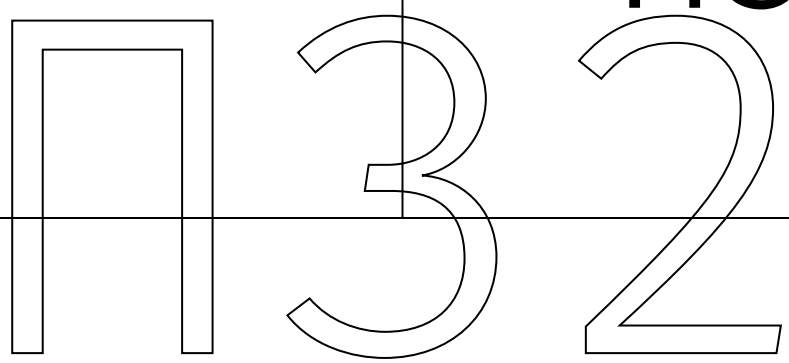

1,583,874 mm

П33

1,119,968 × 1,583,874 mm  
4,294,967,296 per П0  
≈ 1,349.911 km<sup>2</sup> lost due to rounding

П32 ≡ pi thirty-two

791,937 mm

П41



П39

П40

П37

П38

П35

П36

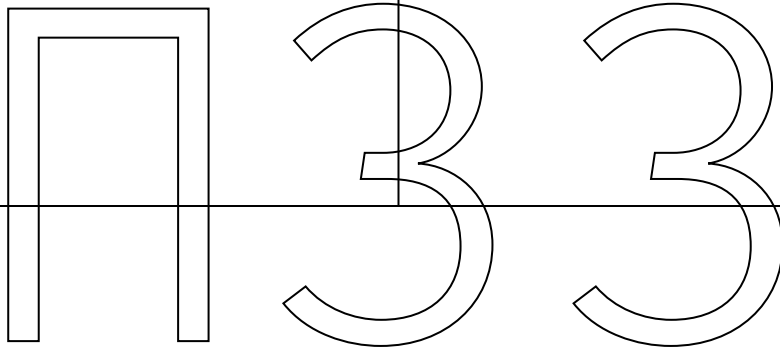

1,119,968 mm

П34

791,937 × 1,119,968 mm

8,589,934,592 per П0

≈ 1,349.911 km<sup>2</sup> lost due to rounding

П33 ≡ pi thirty-three

559,984 mm

П42

П44  
П45

П43

П40

П41

П38

П39

П36

П37

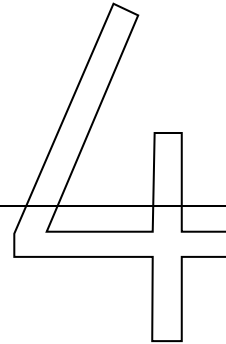
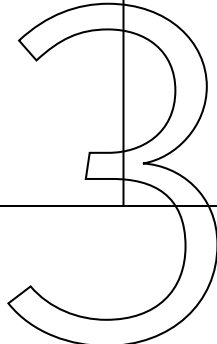
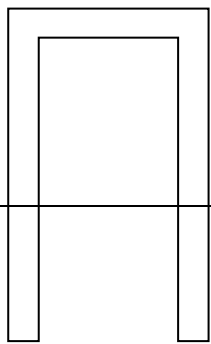

791,937 mm

П35

559,984 × 791,937 mm  
17,179,869,184 per П0  
≈ 1,349.911 km<sup>2</sup> lost due to rounding

П34 ≡ pi thirty-four

395,968 mm

П43

П45

П46

П44

П41

П42

П39

П40

П37

П38

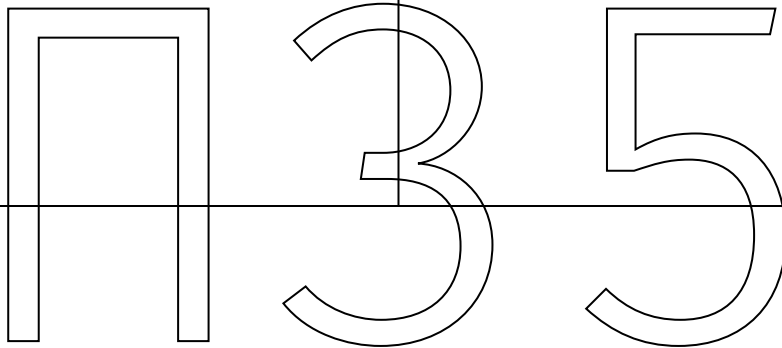

559,984 mm

П36

395,968 × 559,984 mm  
 34,359,738,368 per П0  
 ≈ 10,970.363 km<sup>2</sup> lost due to rounding

П35 ≡ pi thirty-five

279,992 mm

П44

П46  
П47

П45

П42

П43

П40

П41

П38

П39

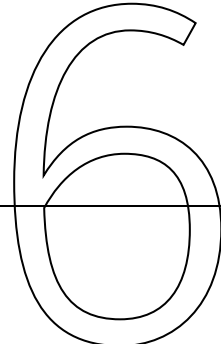
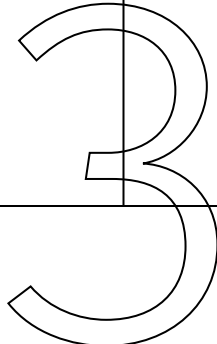
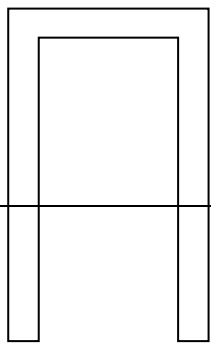

395,968 mm

П37

279,992 × 395,968 mm

68,719,476,736 per П0

≈ 10,970.363 km<sup>2</sup> lost due to rounding

П36 ≡ pi thirty-six

П47  
П48

П45

П46

197,984 mm

П43

П44

П41

П42

П39

П40

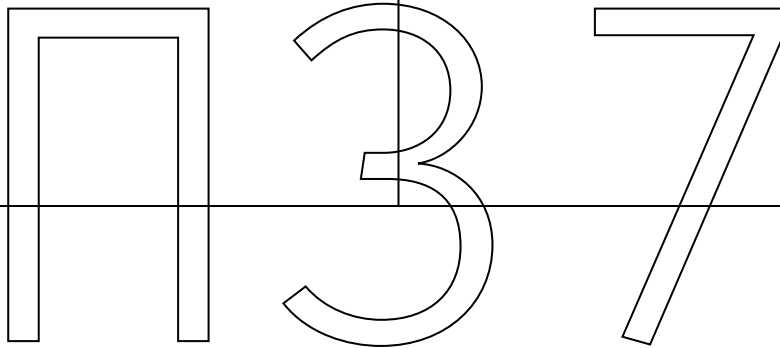

279,992 mm

П38

197,984 × 279,992 mm  
137,438,953,472 per П0  
≈ 10,970.363 km<sup>2</sup> lost due to rounding

П37 ≡ pi thirty-seven



П46  
П47  
П48  
П49

139,996 mm

П44

П45

П42

П43

П40

П41

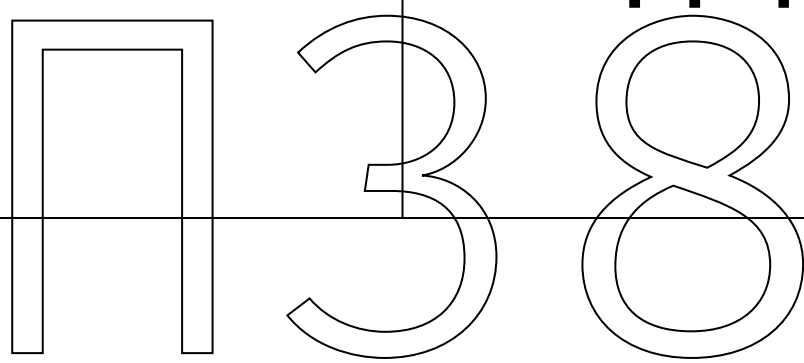

197,984 mm

П39

139,996 × 197,984 mm  
274,877,906,944 per П0  
≈ 10,970.363 km<sup>2</sup> lost due to rounding

П38 ≡ pi thirty-eight

π49  
π50  
π47  
π48

98,992 mm

π45

π46

π43

π44

π41

π42

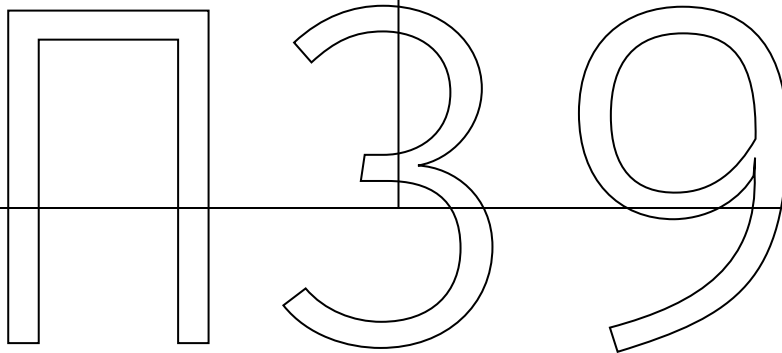

139,996 mm

π40

98,992 × 139,996 mm  
549,755,813,888 per π0  
≈ 10,970.363 km<sup>2</sup> lost due to rounding

π39 ≡ pi thirty-nine

П42

69,998 mm

П44

П46

П48

П49

П47

П45

П43

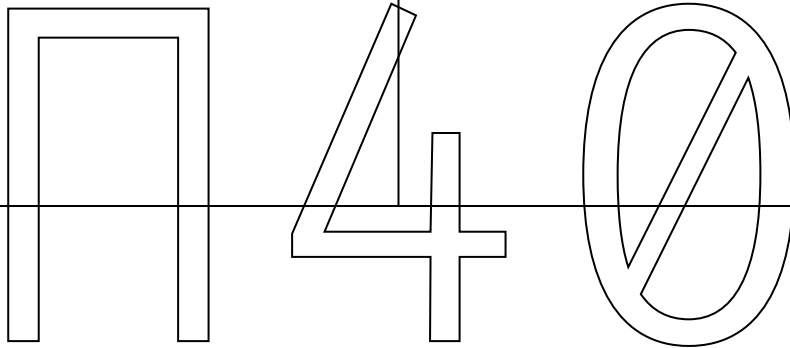

98,992 mm

П41

69,998 × 98,992 mm  
 1,099,511,627,776 per П0  
 ≈ 10,970.363 km<sup>2</sup> lost due to rounding

П40 ≡ pi forty

π51	π52
π50	

π49

π47

π48

49,496 mm

π45

π46

π43

π44

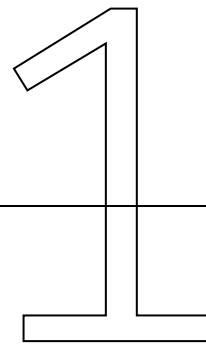
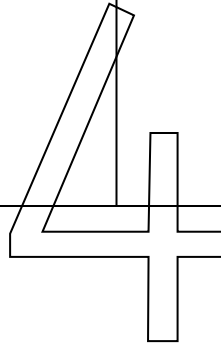
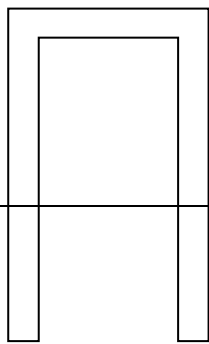

69,998 mm

π42

49,496 × 69,998 mm

2,199,023,255,552 per π0

≈ 10,970.363 km<sup>2</sup> lost due to rounding

π41 ≡ pi forty-one

π50  
π51  
π52  
π53

34,999 mm

π48

π49

π46

π47

π44

π45

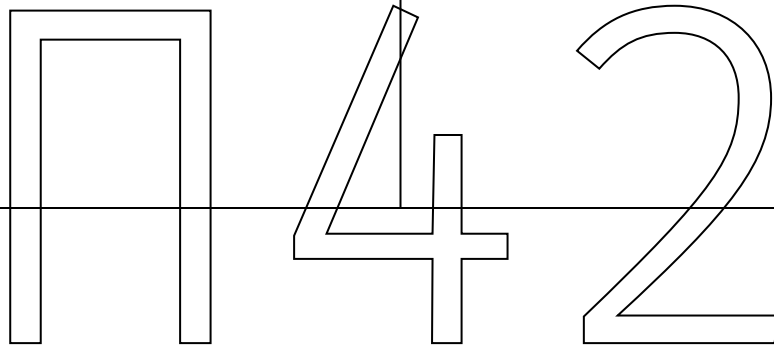

49,496 mm

π43

34,999 × 49,496 mm  
4,398,046,511,104 per π0  
≈ 10,970.363 km<sup>2</sup> lost due to rounding

π42 ≡ pi forty-two

π51  
π52  
π53  
π54

24,748 mm

π49

π50

π47

π48

π45

π46

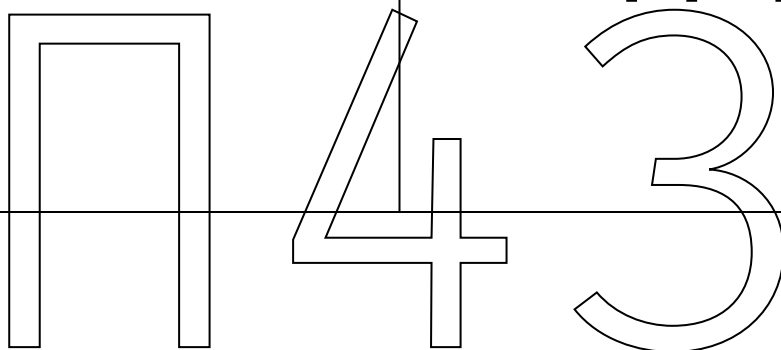

34,999 mm

π44

24,748 × 34,999 mm

8,796,093,022,208 per π0

≈ 10,970.363 km<sup>2</sup> lost due to rounding

π43 ≡ pi forty-three



π54  
π55

π52

π53

π50

π51

17,499 mm

π48

π49

π46

π47

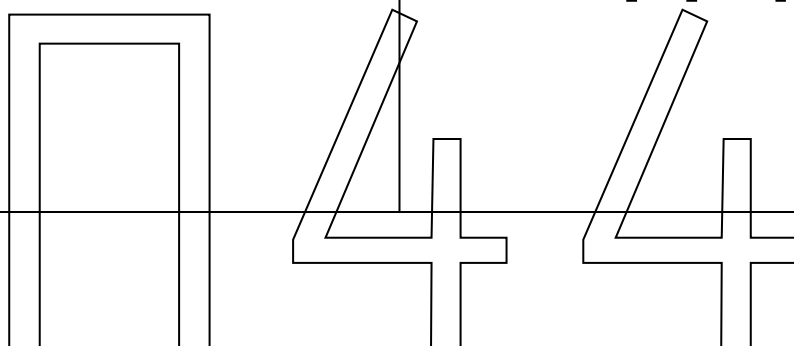

24,748 mm

π45

17,499 × 24,748 mm

17,592,186,044,416 per π0

≈ 228,656.073 km<sup>2</sup> lost due to rounding

π44 ≡ pi forty-four

П47

12,374 mm

П49

П51

П53

П55

П56

П54

П52

П50

П48

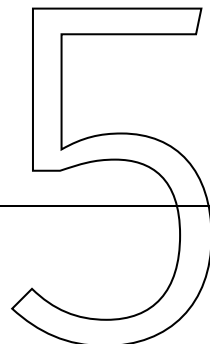
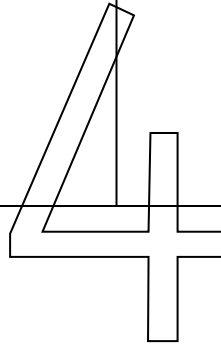
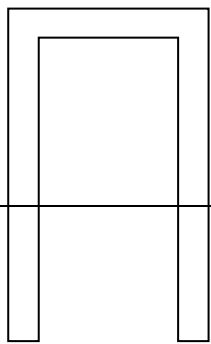

17,499 mm

П46

12,374 × 17,499 mm

35,184,372,088,832 per П0

≈ 228,656.073 km<sup>2</sup> lost due to rounding

П45 ≡ pi forty-five



П48

8,749 mm

П50

П52

П54

П56  
П57  
П55

П53

П51

П49

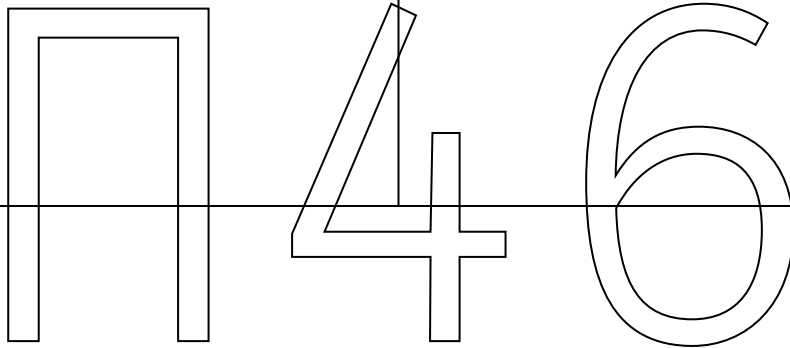

12,374 mm

П47

8,749 × 12,374 mm

70,368,744,177,664 per П0

≈ 664,027.494 km<sup>2</sup> lost due to rounding

П46 ≡ pi forty-six



π55

π57

π58

π56

π53

π54

6,187 mm

π51

π52

π49

π50

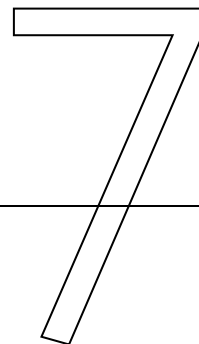
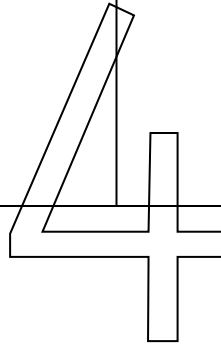
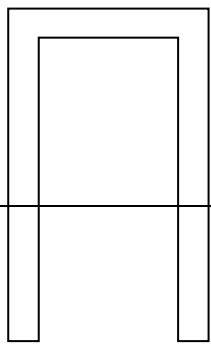

8,749 mm

π48

6,187 × 8,749 mm

140,737,488,355,328 per π0

≈ 664,027.494 km<sup>2</sup> lost due to rounding

π47 ≡ pi forty-seven

П50

4,374 mm

П52

П54

П56

П58

П59

П57

П55

П53

П51

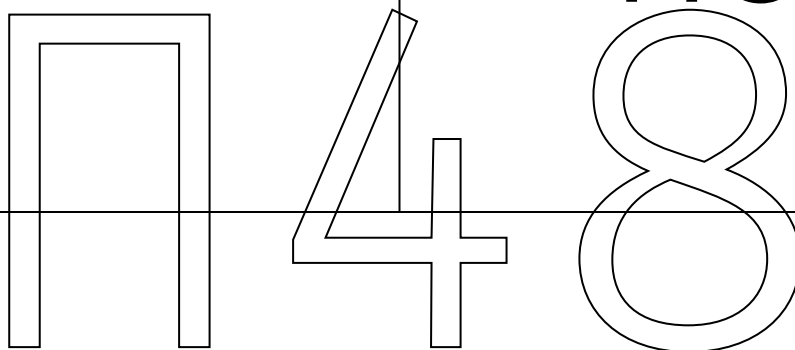

6,187 mm

П49

4,374 × 6,187 mm

281,474,976,710,656 per П0

≈ 1,534,770.334 km² lost due to rounding

П48 ≡ pi forty-eight

π59  
π60

π57

π58

π55

π56

3,093 mm

π53

π54

π51

π52

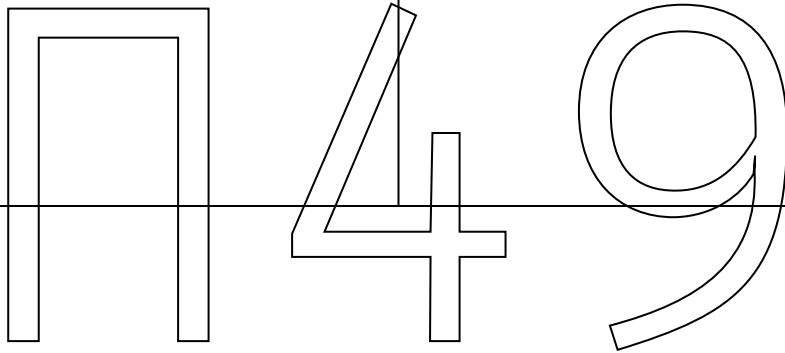

4,374 mm

π50

3,093 × 4,374 mm

562,949,953,421,312 per π0

≈ 2,765,941.882 km² lost due to rounding

π49 ≡ pi forty-nine

П52

2,187 mm

П54

П56

П58

П60

П61

П59

П57

П55

П53

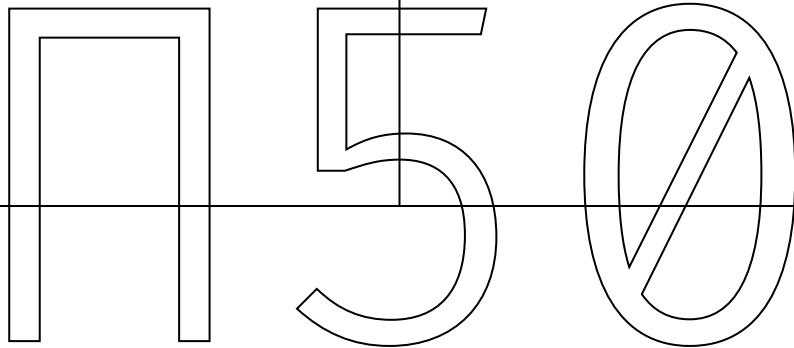

3,093 mm

П51

2,187 × 3,093 mm

1,125,899,906,842,624 per П0

≈ 2,765,941.882 km² lost due to rounding

П50 ≡ pi fifty

П53

1,546 mm

П55

П57

П59

П61

П62

П60

П58

П56

П54

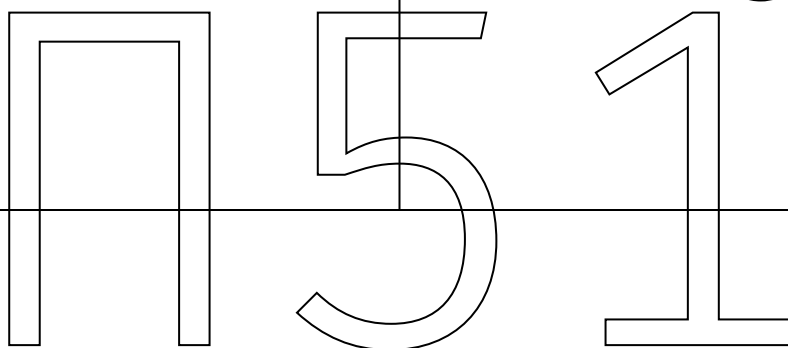

2,187 mm

П52

1,546 × 2,187 mm

2,251,799,813,685,248 per П0

≈ 5,228,284.978 km<sup>2</sup> lost due to rounding

П51 ≡ pi fifty-one

П54

1,093 mm

П56

П58

П60

П62

П63

П61

П59

П57

П55

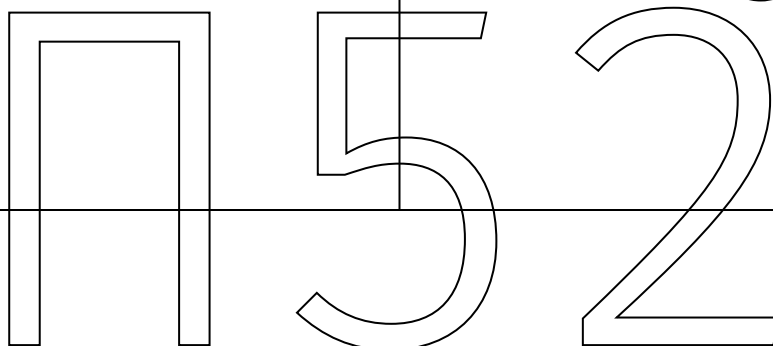

1,546 mm

П53

1,093 × 1,546 mm

4,503,599,627,370,496 per П0

≈ 8,709,567.49 km² lost due to rounding

П52 ≡ pi fifty-two

П55

773 mm

П57

П59

П61

П63

П62

П60

П58

П56

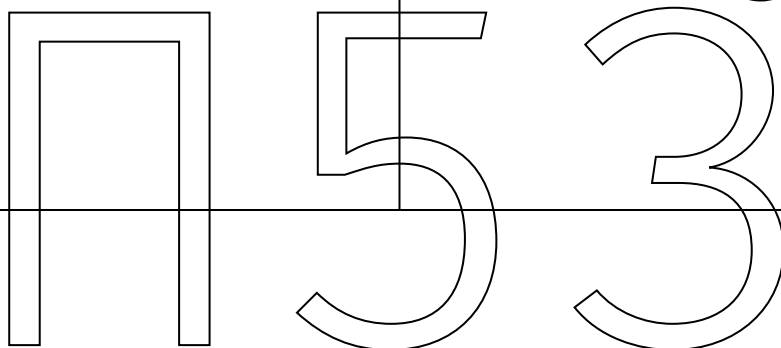

1,093 mm

П54

773 × 1,093 mm

9,007,199,254,740,992 per П0

≈ 8,709,567.49 km<sup>2</sup> lost due to rounding

П53 ≡ pi fifty-three



546 mm

П62

П63

П60

П61

П58

П59

П56

П57

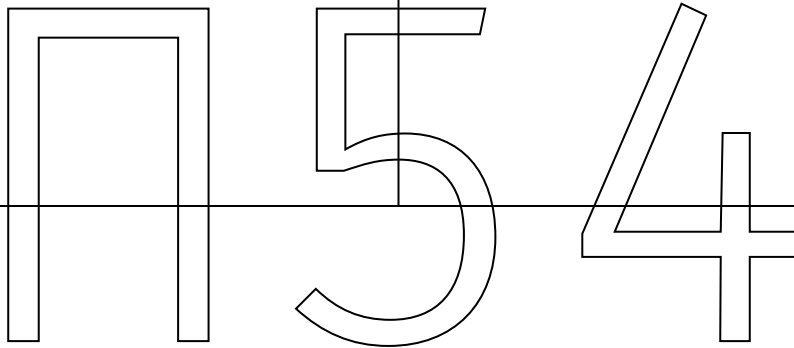

773 mm

П55

546 × 773 mm

18,014,398,509,481,984 per П0

≈ 15,672,132.514 km<sup>2</sup> lost due to rounding

П54 ≡ pi fifty-four

П57

386 mm

П59

П61

П63

П62

П60

П58

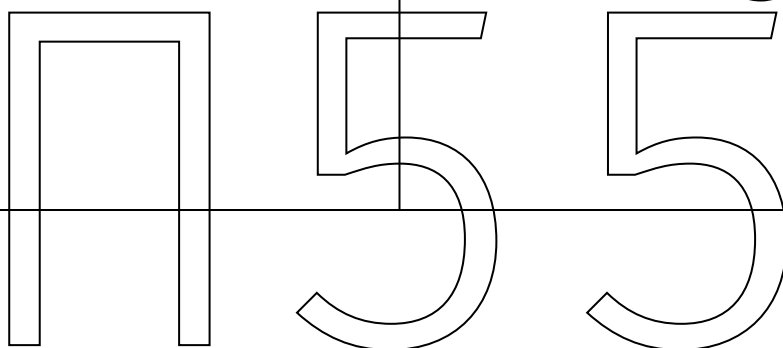

546 mm

П56

386 × 546 mm

36,028,797,018,963,968 per П0

≈ 25,507,994.1 km<sup>2</sup> lost due to rounding

П55 ≡ pi fifty-five

273 mm

П62

П63

П60

П61

П58

П59

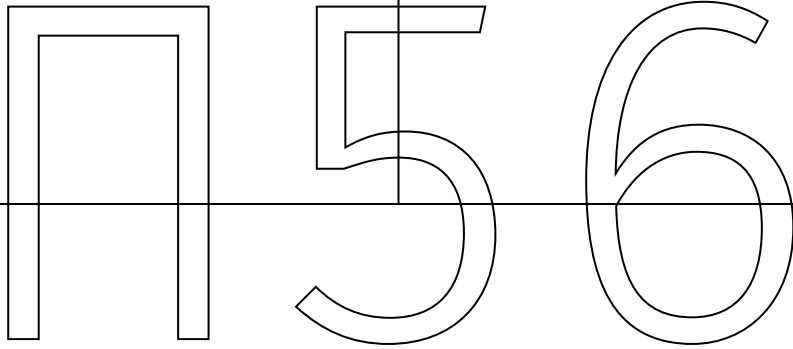

386 mm

П57

273 × 386 mm

72,057,594,037,927,936 per П0

≈ 25,507,994.1 km<sup>2</sup> lost due to rounding

П56 ≡ pi fifty-six

193 mm

П63

П61

П62

П59

П60

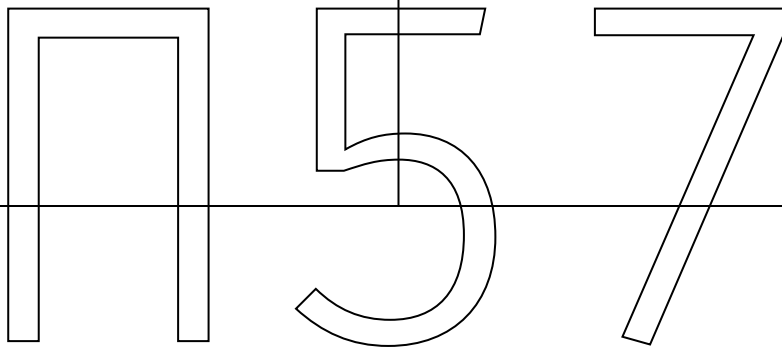

273 mm

П58

193 × 273 mm

144,115,188,075,855,872 per П0

≈ 25,507,994.1 km<sup>2</sup> lost due to rounding

П57 ≡ pi fifty-seven

136 mm

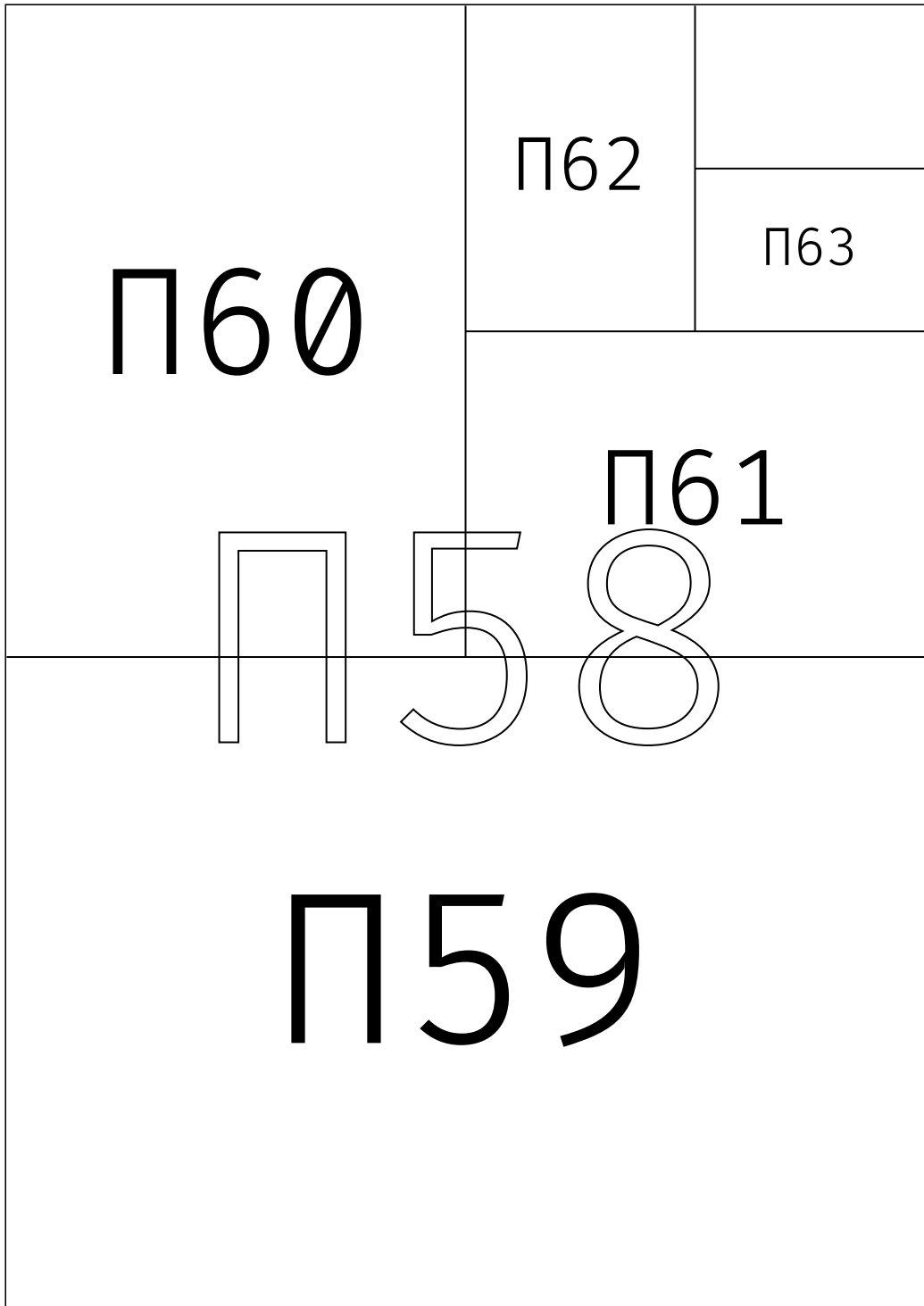

136 × 193 mm

288,230,376,151,711,744 per П0

≈ 53,322,225.399 km<sup>2</sup> lost due to rounding

П58 ≡ pi fifty-eight

96 mm

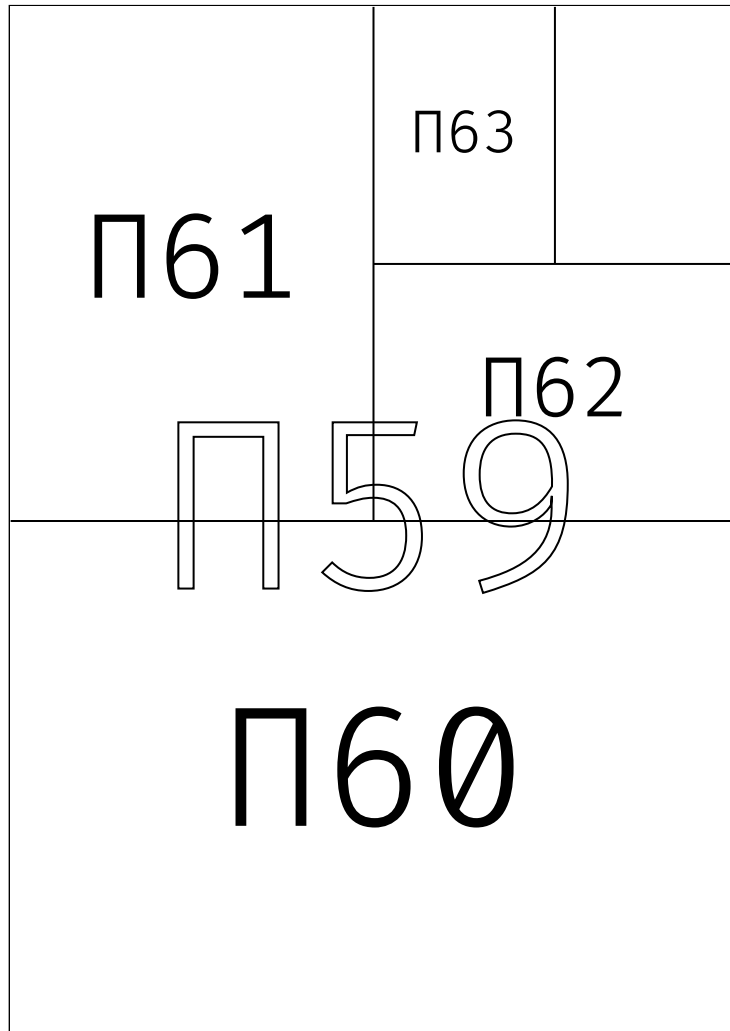

136 mm

96 × 136 mm

576,460,752,303,423,488 per П0

≈ 92,521,556.556 km<sup>2</sup> lost due to rounding

П59 ≡ pi fifty-nine

68 mm

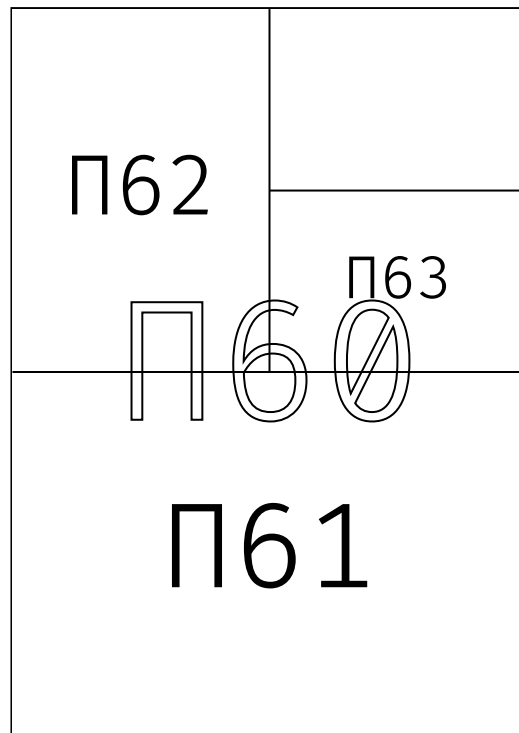

96 mm

68 × 96 mm

1,152,921,504,606,846,976 per П0

≈ 92,521,556.556 km<sup>2</sup> lost due to rounding

П60 ≡ pi sixty

48 mm

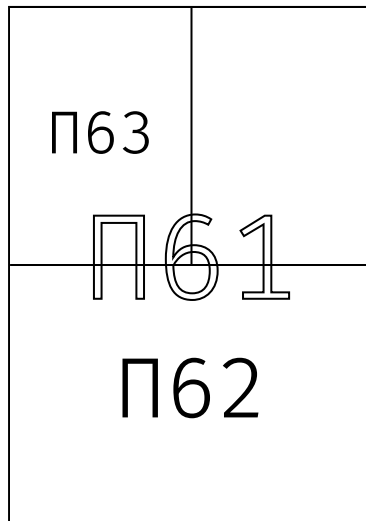

68 mm

48 × 68 mm

2,305,843,009,213,693,952 per П0

≈ 92,521,556.556 km<sup>2</sup> lost due to rounding

П61 ≡ pi sixty-one



34 mm



48 mm

34 × 48 mm

4,611,686,018,427,387,904 per Π0

≈ 92,521,556.556 km<sup>2</sup> lost due to rounding

Π62 ≡ pi sixty-two

24 mm



34 mm

24 × 34 mm

9,223,372,036,854,775,808 per П0

≈ 92,521,556.556 km<sup>2</sup> lost due to rounding

П63 ≡ pi sixty-three