

Z0 = area of Jupiter ± 1 mm

Z0 → Z66

208,482.848,451,356,08 km

Z (zêta)
0-66

JUPITER

294,839.271,802,082,4 km

equatorial radius : 71,492 km
polar radius : 66,854 km

calculated area : 61,468,931,220.621,735 km²
rectangle with an area equal to Jupiter and a ratio of $1:\sqrt{2}$:
width : 208,482.848,451,356,08 km
height : 294,839.271,802,082,4 km

This series is printed in the format α60 (194 × 274 mm), the first format that can be affixed on an A4 format.

208,482,848,451 mm

Z8

Z10

Z11

Z9

Z6

Z7

Z4

Z5

Z2

Z3

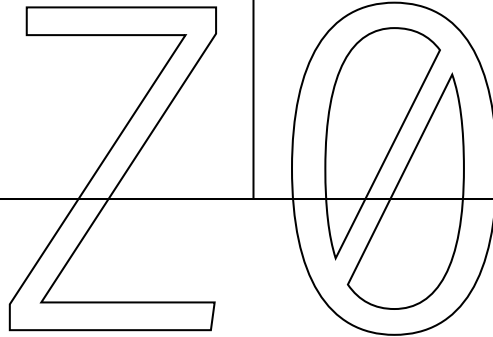

294,839,271,802 mm

Z1

208,482,848,451 × 294,839,271,802 mm

1 per Z0

≈ 0.122 km² lost due to rounding

Z0 ≡ zêta zero

147,419,635,901 mm

Z9

Z11
Z12
Z10

Z7

Z8

Z5

Z6

Z3

Z4

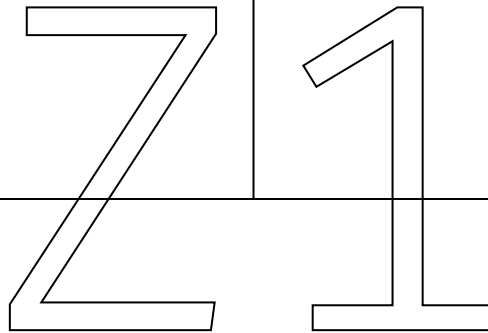

208,482,848,451 mm

Z2

147,419,635,901 × 208,482,848,451 mm

2 per Z0

≈ 0.122 km² lost due to rounding

Z1 ≡ zêta one

104,241,424,225 mm

Z10

Z12

Z13

Z11

Z8

Z9

Z6

Z7

Z4

Z5

Z2

147,419,635,901 mm

Z3

104,241,424,225 × 147,419,635,901 mm

4 per Z0

≈ 0.417 km² lost due to rounding

Z2 ≡ zêta two

73,709,817,950 mm

Z11

Z13

Z14

Z12

Z9

Z10

Z7

Z8

Z5

Z6

Z3

104,241,424,225 mm

Z4

73,709,817,950 × 104,241,424,225 mm

8 per Z0

≈ 0.834 km² lost due to rounding

Z3 ≡ zêta three

52,120,712,112 mm

Z12

Z14
Z15

Z10

Z13

Z11

Z8

Z9

Z6

Z7

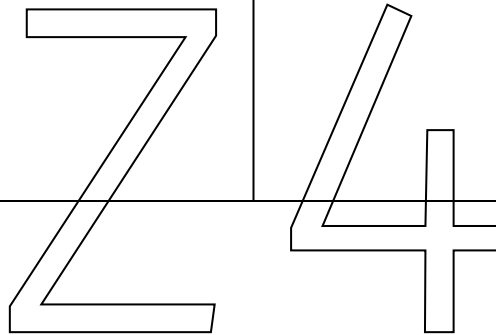

73,709,817,950 mm

Z5

52,120,712,112 × 73,709,817,950 mm
16 per Z0
≈ 1.424 km² lost due to rounding

Z4 ≡ zêta four

36,854,908,975 mm

Z13

Z15
Z14
Z16

Z11

Z12

Z9

Z10

Z7

Z8

Z5

52,120,712,112 mm

Z6

36,854,908,975 × 52,120,712,112 mm

32 per Z0

≈ 1.424 km² lost due to rounding

Z5 ≡ zêta five

26,060,356,056 mm

Z14

Z16
Z17

Z15

Z12

Z13

Z10

Z11

Z8

Z9

Z6

36,854,908,975 mm

Z7

26,060,356,056 × 36,854,908,975 mm

64 per Z0

≈ 1.424 km² lost due to rounding

Z6 ≡ zêta six

18,427,454,487 mm

Z15

Z17

Z18

Z16

Z13

Z14

Z11

Z12

Z9

Z10

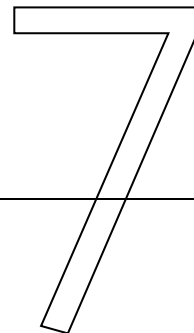
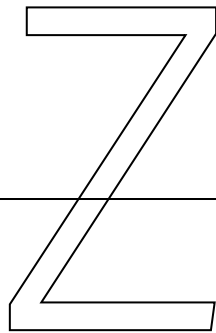

26,060,356,056 mm

Z8

18,427,454,487 × 26,060,356,056 mm

128 per Z0

≈ 3.092 km² lost due to rounding

Z7 ≡ zêta seven

13,030,178,028 mm

Z16

Z18

Z19

Z17

Z14

Z15

Z12

Z13

Z10

Z11

Z8

18,427,454,487 mm

Z9

13,030,178,028 × 18,427,454,487 mm

256 per Z0

≈ 3.092 km² lost due to rounding

Z8 ≡ zêta eight

Z19
Z20

Z17

Z18

9,213,727,243 mm

Z15

Z16

Z13

Z14

Z11

Z12

Z9

13,030,178,028 mm

Z10

9,213,727,243 × 13,030,178,028 mm
512 per Z0
≈6.427 km² lost due to rounding

Z9 ≡ zêta nine

Z20
Z21

Z18

Z19

Z16

Z17

6,515,089,014 mm

Z14

Z15

Z12

Z13

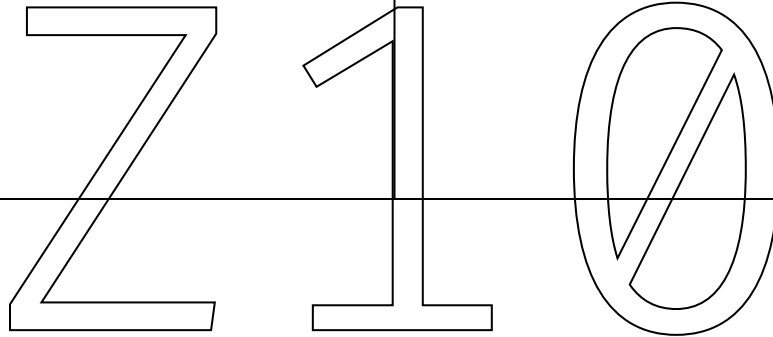

9,213,727,243 mm

Z11

6,515,089,014 × 9,213,727,243 mm

1,024 per Z0

≈6.427 km² lost due to rounding

Z10 ≡ zêta ten

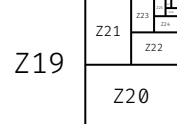

4,606,863,621 mm

Z17

Z15

Z18

Z16

Z13

Z14

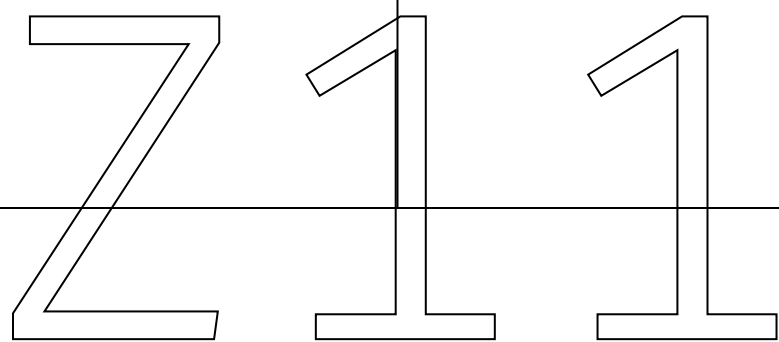

6,515,089,014 mm

Z12

4,606,863,621 × 6,515,089,014 mm
 2,048 per Z0
 ≈13.099 km² lost due to rounding

Z11 ≡ zêta eleven

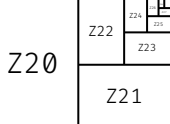

3,257,544,507 mm

Z18

Z19

Z16

Z17

Z14

Z15

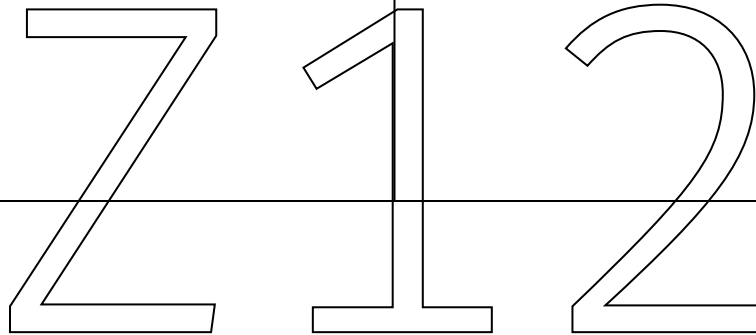

4,606,863,621 mm

Z13

$3,257,544,507 \times 4,606,863,621$ mm

4,096 per Z0

≈ 13.099 km² lost due to rounding

Z12 \equiv zêta twelve



2,303,431,810 mm

Z19

Z21

Z23
Z24

Z22

Z20

Z17

Z18

Z15

Z16

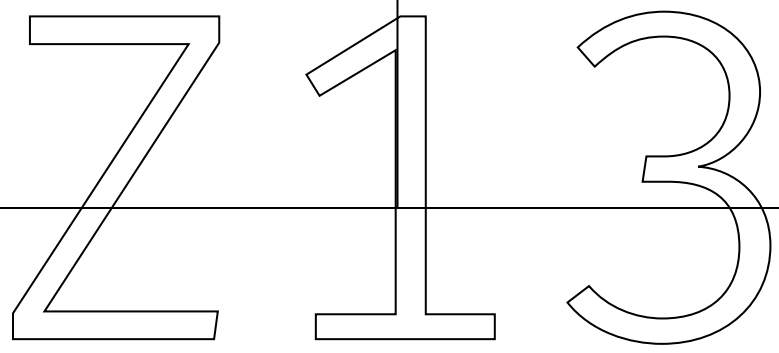

3,257,544,507 mm

Z14

2,303,431,810 × 3,257,544,507 mm
 8,192 per Z0
 ≈26.442 km² lost due to rounding

Z13 ≡ zêta thirteen

1,628,772,253 mm

Z22

Z24

Z25

Z23

Z20

Z21

Z18

Z19

Z16

Z17

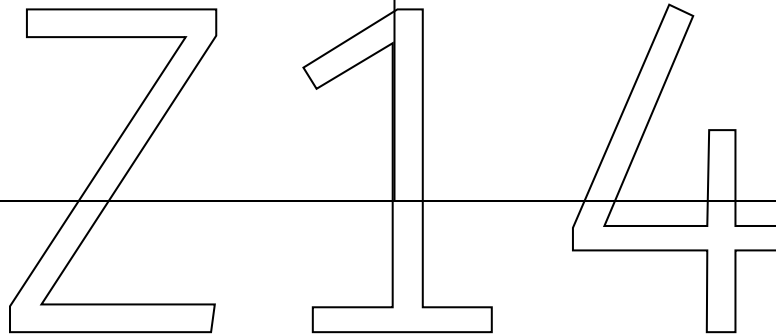

2,303,431,810 mm

Z15

1,628,772,253 × 2,303,431,810 mm
 16,384 per Z0
 ≈45.311 km² lost due to rounding

Z14 ≡ zêta fourteen



Z23

Z24

Z25

Z26

Z21

Z22

Z20

1,151,715,905 mm

Z19

Z17

Z18

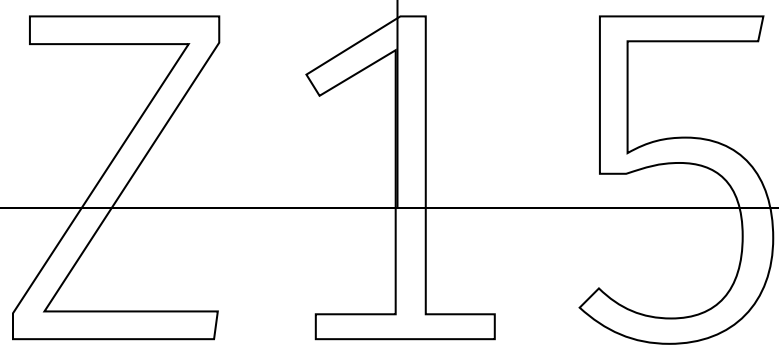

1,628,772,253 mm

Z16

1,151,715,905 × 1,628,772,253 mm
 32,768 per Z0
 ≈ 45.311 km² lost due to rounding

Z15 ≡ zêta fifteen

814,386,126 mm

Z24

Z26
Z27

Z25

Z22

Z23

Z20

Z21

Z18

Z19

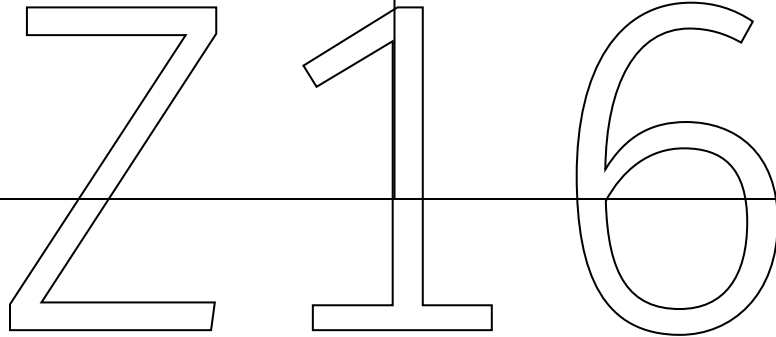

1,151,715,905 mm

Z17

814,386,126 × 1,151,715,905 mm
65,536 per Z0
≈ 83.051 km² lost due to rounding

Z16 ≡ zêta sixteen

Z27	Z28
Z26	

Z25

Z23

Z26

Z24

575,857,952 mm

Z21

Z22

Z19

Z20

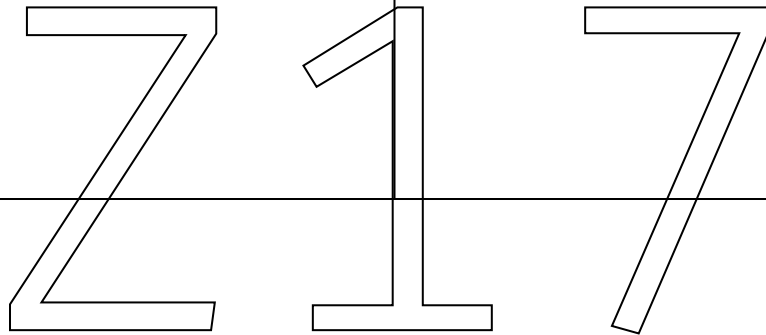

814,386,126 mm

Z18

575,857,952 × 814,386,126 mm
 131,072 per Z0
 ≈ 136.422 km² lost due to rounding

Z17 ≡ zêta seventeen

407,193,063 mm

Z26

Z28

Z29

Z27

Z24

Z25

Z22

Z23

Z20

Z21

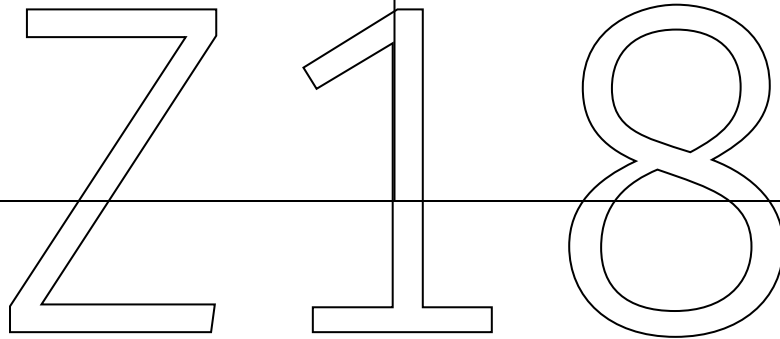

575,857,952 mm

Z19

407,193,063 × 575,857,952 mm

262,144 per Z0

≈ 136.422 km² lost due to rounding

Z18 ≡ zêta eighteen

287,928,976 mm

Z27

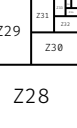

Z25

Z26

Z23

Z24

Z21

Z22

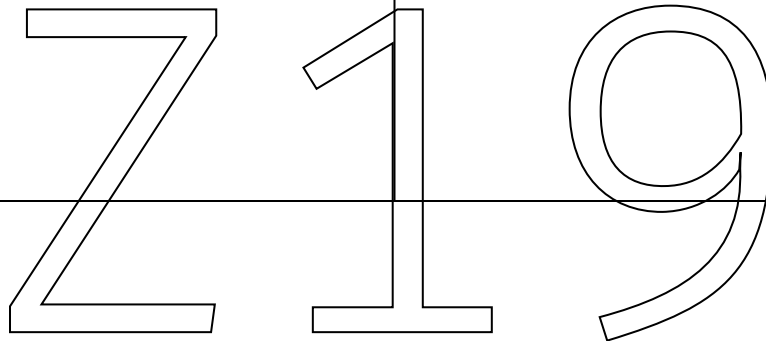

407,193,063 mm

Z20

287,928,976 × 407,193,063 mm
 524,288 per Z0
 ≈ 136.422 km² lost due to rounding

Z19 ≡ zêta nineteen

203,596,531 mm

Z28

Z30

Z31

Z29

Z26

Z27

Z24

Z25

Z22

Z23

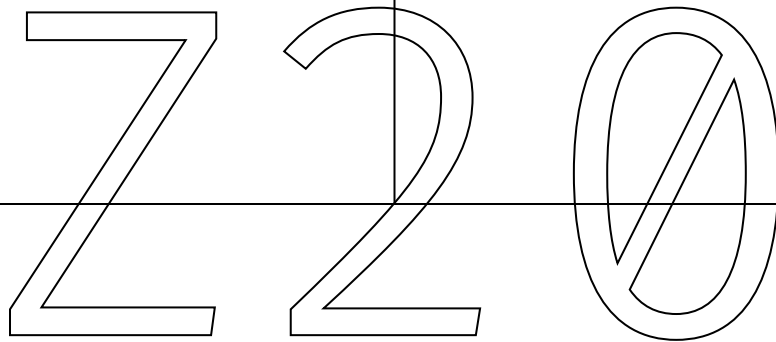

287,928,976 mm

Z21

203,596,531 × 287,928,976 mm

1,048,576 per Z0

≈ 287.38 km² lost due to rounding

Z20 ≡ zêta twenty

143,964,488 mm

Z29

Z31
Z32
Z30

Z27

Z28

Z25

Z26

Z23

Z24

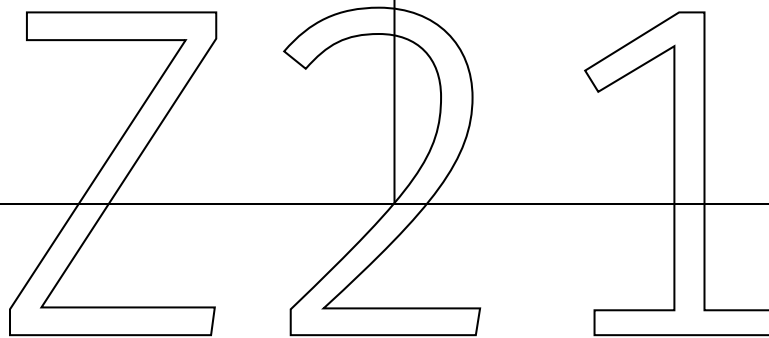

203,596,531 mm

Z22

143,964,488 × 203,596,531 mm
2,097,152 per Z0
≈ 287.38 km² lost due to rounding

Z21 ≡ zêta twenty-one

101,798,265 mm

Z30

Z32
Z33

Z31

Z28

Z29

Z26

Z27

Z24

Z25

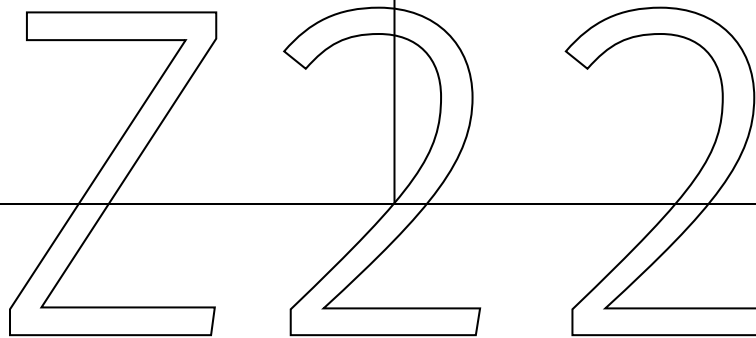

143,964,488 mm

Z23

101,798,265 × 143,964,488 mm
4,194,304 per Z0
≈ 589.295 km² lost due to rounding

Z22 ≡ zêta twenty-two



Z31

Z33

Z34

Z32

71,982,244 mm

Z29

Z30

Z27

Z28

Z25

Z26

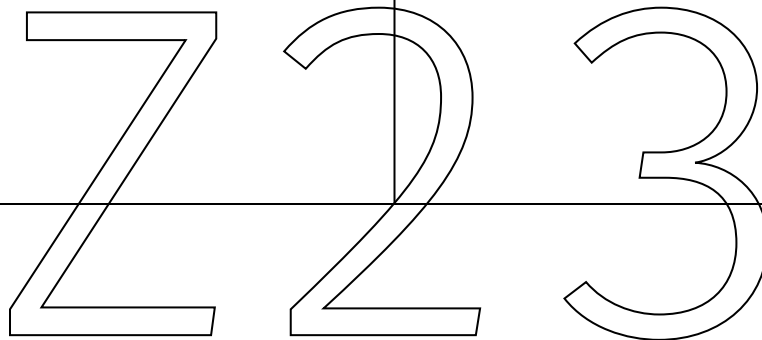

101,798,265 mm

Z24

71,982,244 × 101,798,265 mm
8,388,608 per Z0
≈ 589.295 km² lost due to rounding

Z23 ≡ zêta twenty-three

Z34
Z35

Z32

Z33

50,899,132 mm

Z30

Z31

Z28

Z29

Z26

Z27

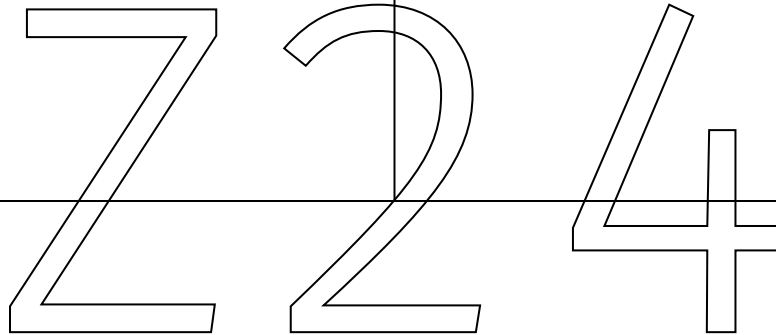

71,982,244 mm

Z25

50,899,132 × 71,982,244 mm

16,777,216 per Z0

≈ 1,193.126 km² lost due to rounding

Z24 ≡ zêta twenty-four

Z27

35,991,122 mm

Z29

Z31

Z33

Z35

Z36

Z34

Z32

Z30

Z28

Z25

50,899,132 mm

Z26

35,991,122 × 50,899,132 mm

33,554,432 per Z0

≈ 1,193.126 km² lost due to rounding

Z25 ≡ zêta twenty-five

25,449,566 mm

Z34

Z36

Z37

Z35

Z32

Z33

Z30

Z31

Z28

Z29

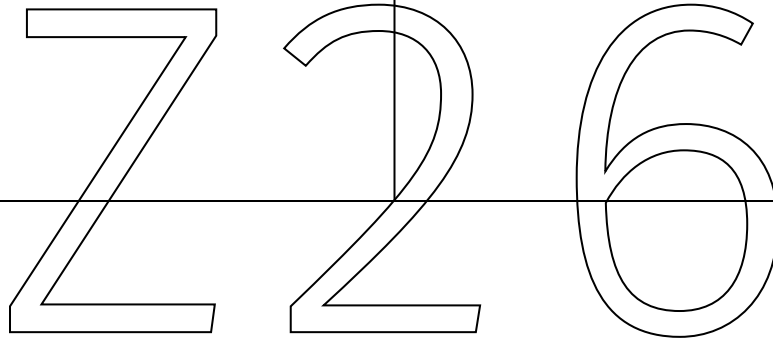

35,991,122 mm

Z27

25,449,566 × 35,991,122 mm

67,108,864 per Z0

≈ 1,193.126 km² lost due to rounding

Z26 ≡ zêta twenty-six

17,995,561 mm

Z35

Z37
Z38

Z33

Z36

Z34

Z31

Z32

Z29

Z30

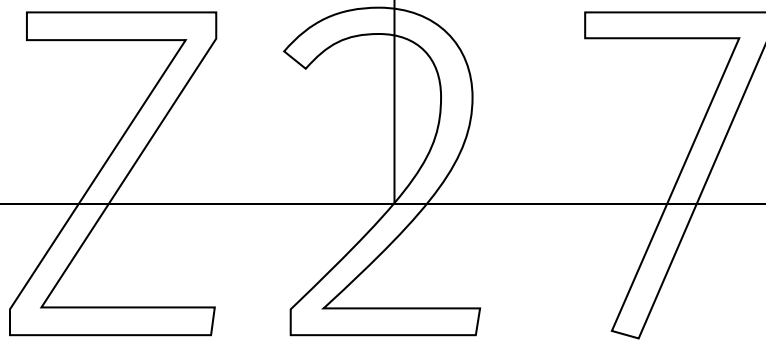

25,449,566 mm

Z28

17,995,561 × 25,449,566 mm
134,217,728 per Z0
≈ 1,193.126 km² lost due to rounding

Z27 ≡ zêta twenty-seven

12,724,783 mm

Z36

Z38
Z39

Z34

Z37

Z35

Z32

Z33

Z30

Z31

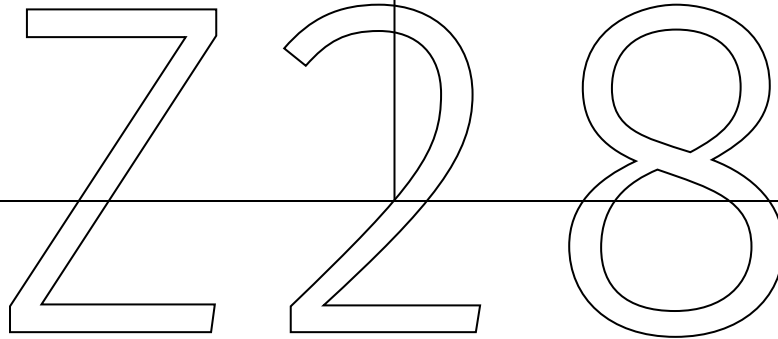

17,995,561 mm

Z29

12,724,783 × 17,995,561 mm

268,435,456 per Z0

≈ 1,193.126 km² lost due to rounding

Z28 ≡ zêta twenty-eight

8,997,780 mm

Z37

Z39

Z40

Z38

Z35

Z36

Z33

Z34

Z31

Z32

Z29

12,724,783 mm

Z30

8,997,780 × 12,724,783 mm

536,870,912 per Z0

≈ 4,608.909 km² lost due to rounding

Z29 ≡ zêta twenty-nine

6,362,391 mm

Z38

Z40
Z41

Z36

Z37

Z34

Z35

Z32

Z33

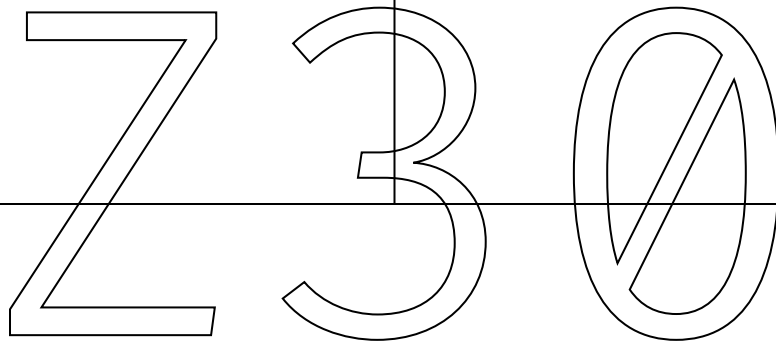

8,997,780 mm

Z31

6,362,391 × 8,997,780 mm

1,073,741,824 per Z0

≈ 9,439.556 km² lost due to rounding

Z30 ≡ zêta thirty

4,498,890 mm

Z39

Z41

Z42

Z40

Z37

Z38

Z35

Z36

Z33

Z34

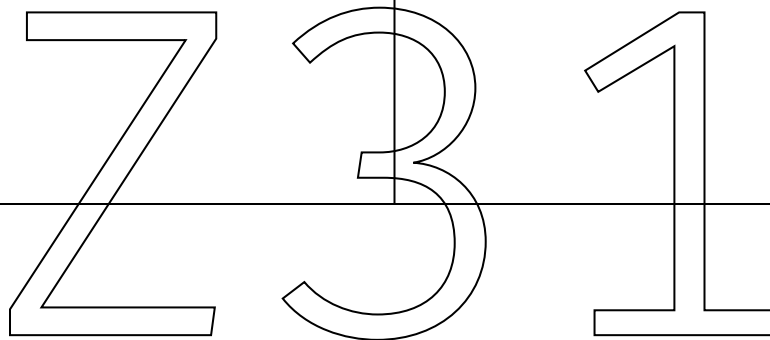

6,362,391 mm

Z32

4,498,890 × 6,362,391 mm

2,147,483,648 per Z0

≈ 9,439.556 km² lost due to rounding

Z31 ≡ zêta thirty-one

3,181,195 mm

Z40

Z42

Z43

Z41

Z38

Z39

Z36

Z37

Z34

Z35

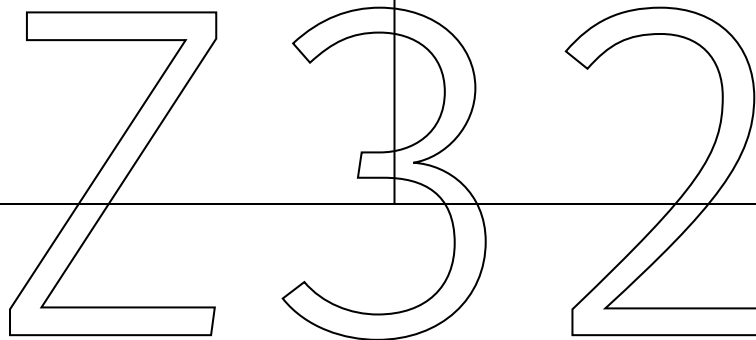

4,498,890 mm

Z33

3,181,195 × 4,498,890 mm

4,294,967,296 per Z0

≈ 19,100.848 km² lost due to rounding

Z32 ≡ zêta thirty-two

2,249,445 mm

Z41

Z43

Z44

Z42

Z39

Z40

Z37

Z38

Z35

Z36

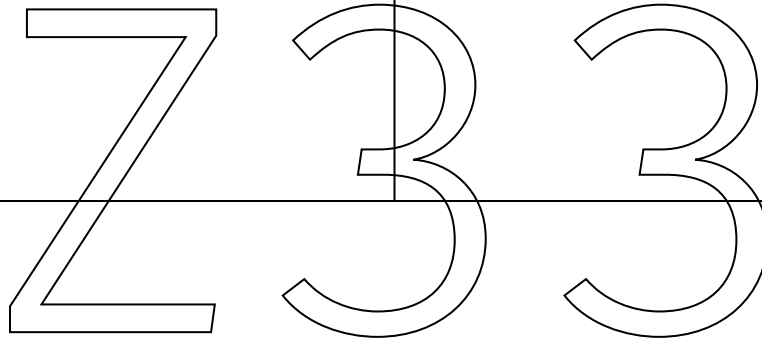

3,181,195 mm

Z34

2,249,445 × 3,181,195 mm

8,589,934,592 per Z0

≈ 19,100.848 km² lost due to rounding

Z33 ≡ zêta thirty-three

1,590,597 mm

Z42

Z44

Z45

Z43

Z40

Z41

Z38

Z39

Z36

Z37

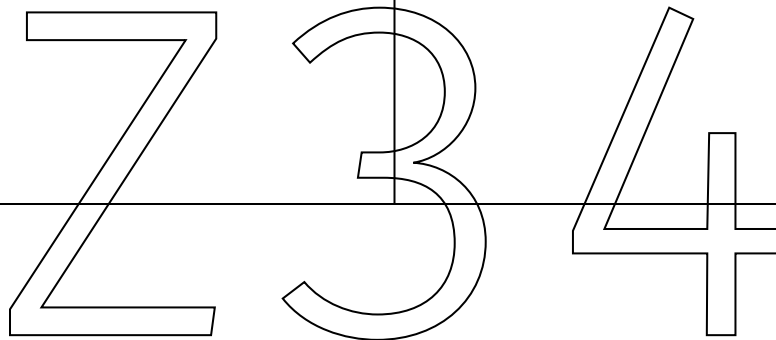

2,249,445 mm

Z35

1,590,597 × 2,249,445 mm

17,179,869,184 per Z0

≈ 38,423.434 km² lost due to rounding

Z34 ≡ zêta thirty-four

1,124,722 mm

Z43

Z45
Z46

Z44

Z41

Z42

Z39

Z40

Z37

Z38

Z35

1,590,597 mm

Z36

1,124,722 × 1,590,597 mm

34,359,738,368 per Z0

≈ 65,749.682 km² lost due to rounding

Z35 ≡ zêta thirty-five

Z38

795,298 mm

Z40

Z42

Z44

Z46

Z47

Z45

Z43

Z41

Z39

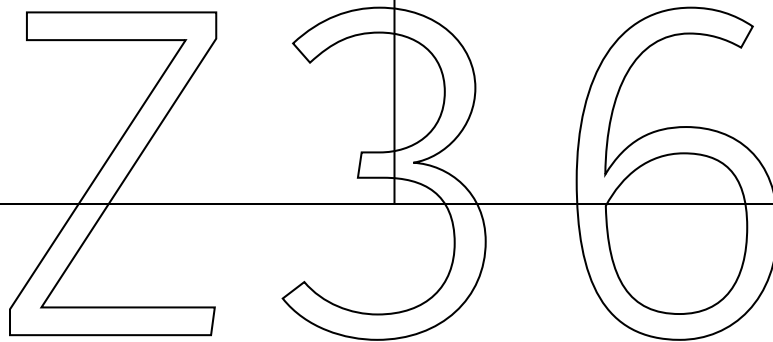

1,124,722 mm

Z37

795,298 × 1,124,722 mm

68,719,476,736 per Z0

≈ 104,394.836 km² lost due to rounding

Z36 ≡ zêta thirty-six

Z39

562,361 mm

Z41

Z43

Z45

Z47

Z48

Z46

Z44

Z42

Z40

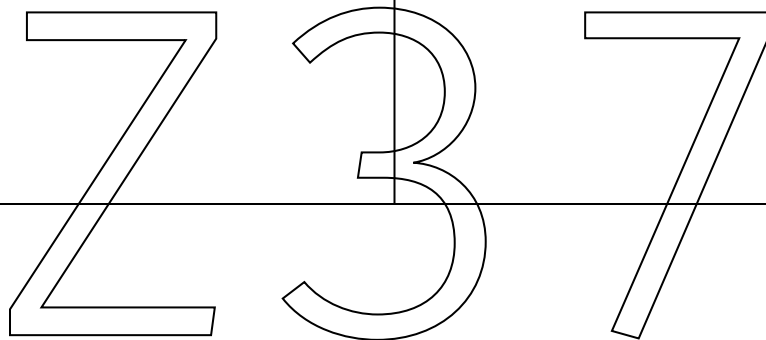

795,298 mm

Z38

562,361 × 795,298 mm
137,438,953,472 per Z0
≈ 104,394.836 km² lost due to rounding

Z37 ≡ zêta thirty-seven

Z48
Z49

Z46

Z47

397,649 mm

Z44

Z45

Z42

Z43

Z40

Z41

Z 3 8

562,361 mm

Z39

397,649 × 562,361 mm
274,877,906,944 per Z0
≈ 104,394.836 km² lost due to rounding

Z38 ≡ zêta thirty-eight

Z49
Z50

Z47

Z48

281,180 mm

Z45

Z46

Z43

Z44

Z41

Z42

Z39

397,649 mm

Z40

281,180 × 397,649 mm
549,755,813,888 per Z0
≈ 213,699.761 km² lost due to rounding

Z39 ≡ zêta thirty-nine

Z42

198,824 mm

Z44

Z46

Z48

Z50	Z51
Z51	Z51

Z49

Z47

Z45

Z43

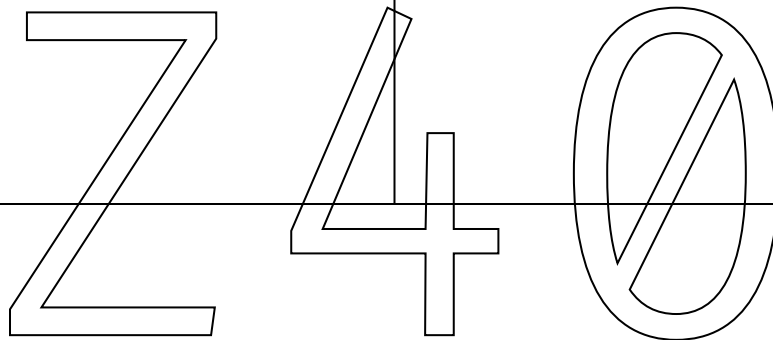

281,180 mm

Z41

198,824 × 281,180 mm
1,099,511,627,776 per Z0
≈ 368,280.1 km² lost due to rounding

Z40 ≡ zêta forty

Z43

140,590 mm

Z45

Z47

Z49

Z51
Z52
Z50

Z48

Z46

Z44

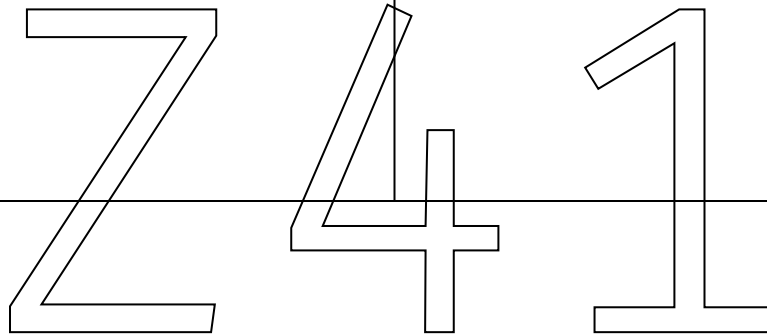

198,824 mm

Z42

140,590 × 198,824 mm
2,199,023,255,552 per Z0
≈ 368,280.1 km² lost due to rounding

Z41 ≡ zêta forty-one

Z44

99,412 mm

Z46

Z48

Z50

Z52
Z53

Z51

Z49

Z47

Z45

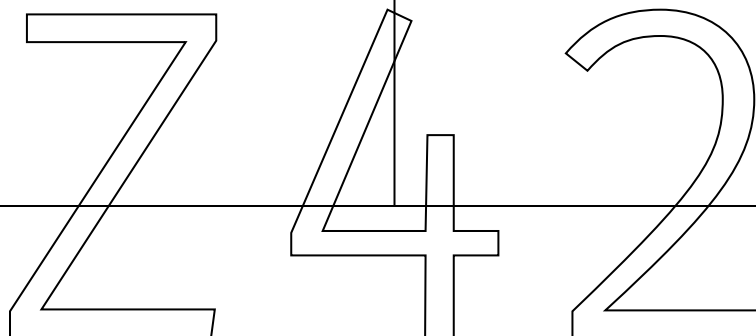

140,590 mm

Z43

99,412 × 140,590 mm

4,398,046,511,104 per Z0

≈ 368,280.1 km² lost due to rounding

Z42 ≡ zêta forty-two

Z45

70,295 mm

Z47

Z49

Z51

Z53

Z54

Z52

Z50

Z48

Z46

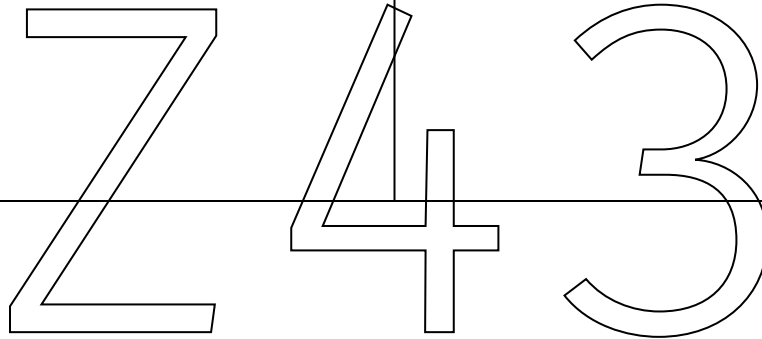

99,412 mm

Z44

70,295 × 99,412 mm

8,796,093,022,208 per Z0

≈ 368,280.1 km² lost due to rounding

Z43 ≡ zêta forty-three

Z46

49,706 mm

Z48

Z50

Z52

Z54
Z55

Z53

Z51

Z49

Z47

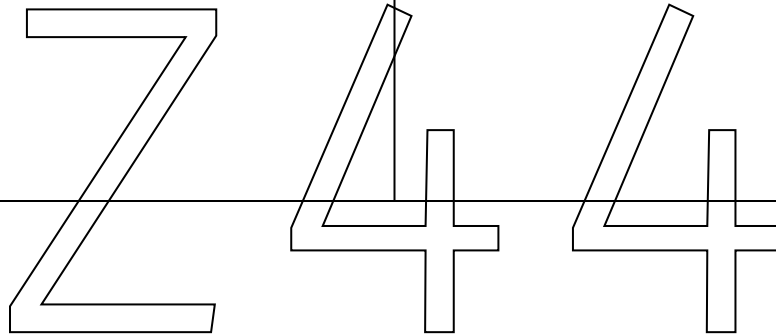

70,295 mm

Z45

49,706 × 70,295 mm
17,592,186,044,416 per Z0
≈ 368,280.1 km² lost due to rounding

Z44 ≡ zêta forty-four

Z47

35,147 mm

Z49

Z51

Z53

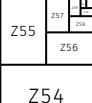

Z52

Z50

Z48

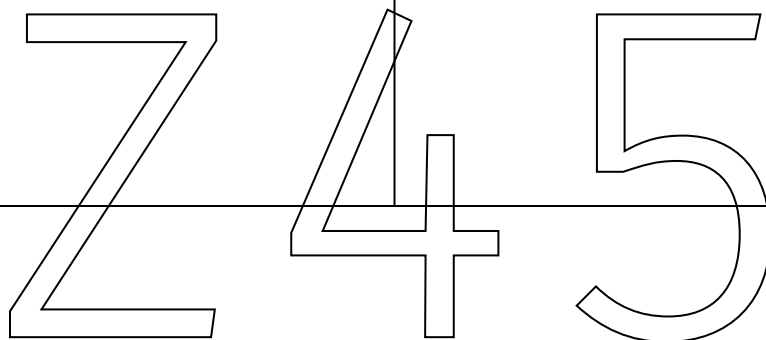

49,706 mm

Z46

35,147 × 49,706 mm

35,184,372,088,832 per Z0

≈ 1,242,717.3 km² lost due to rounding

Z45 ≡ zêta forty-five

Z48

24,853 mm

Z50

Z52

Z54

Z56

Z57

Z55

Z53

Z51

Z49

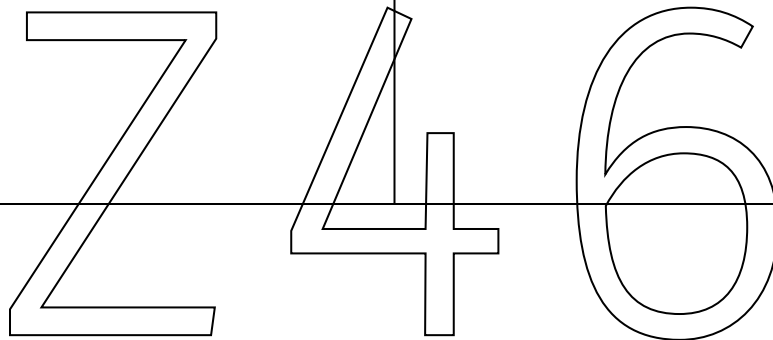

35,147 mm

Z47

24,853 × 35,147 mm

70,368,744,177,664 per Z0

≈ 1,242,717.3 km² lost due to rounding

Z46 ≡ zêta forty-six

Z49

17,573 mm

Z51

Z53

Z55

Z57
Z58

Z56

Z54

Z52

Z50

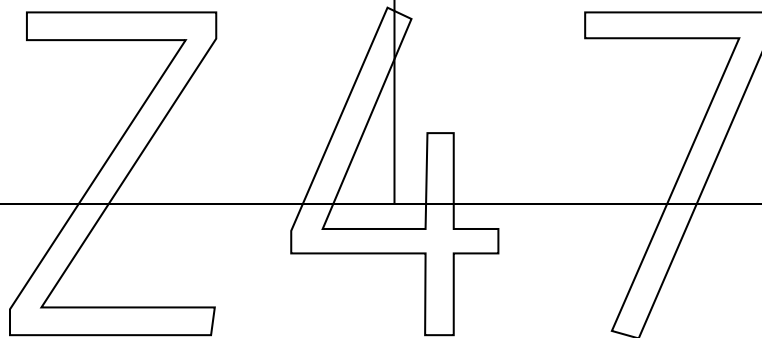

24,853 mm

Z48

17,573 × 24,853 mm

140,737,488,355,328 per Z0

≈ 2,991,591.699 km² lost due to rounding

Z47 ≡ zêta forty-seven

Z50

12,426 mm

Z52

Z54

Z56

Z58

Z59

Z57

Z55

Z53

Z51

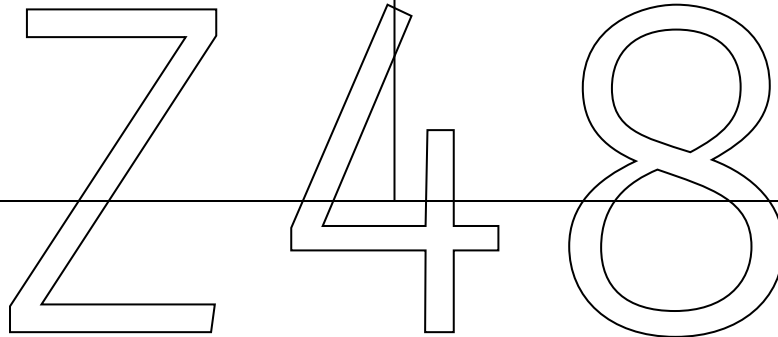

17,573 mm

Z49

12,426 × 17,573 mm

281,474,976,710,656 per Z0

≈ 5,464,771.582 km² lost due to rounding

Z48 ≡ zêta forty-eight

Z51

8,786 mm

Z53

Z55

Z57

Z59

Z60

Z58

Z56

Z54

Z52

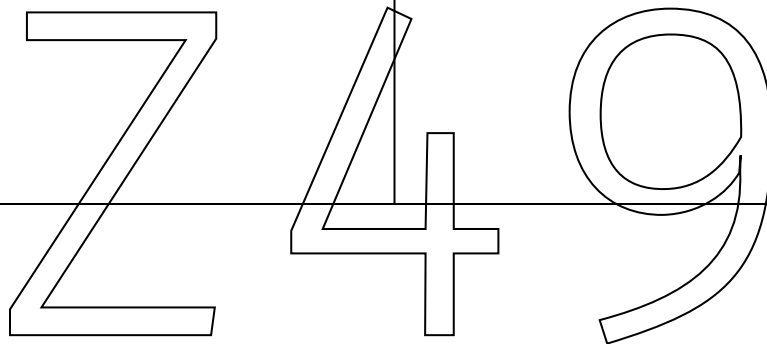

12,426 mm

Z50

8,786 × 12,426 mm

562,949,953,421,312 per Z0

≈ 8,962,379.642 km² lost due to rounding

Z49 ≡ zêta forty-nine

Z52

6,213 mm

Z54

Z56

Z58

Z60

Z61

Z59

Z57

Z55

Z53

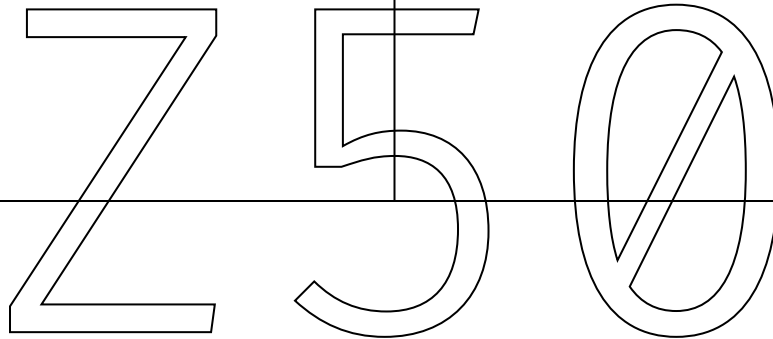

8,786 mm

Z51

6,213 × 8,786 mm

1,125,899,906,842,624 per Z0

≈ 8,962,379.642 km² lost due to rounding

Z50 ≡ zêta fifty

Z53

4,393 mm

Z55

Z57

Z59

Z61

Z62

Z60

Z58

Z56

Z54

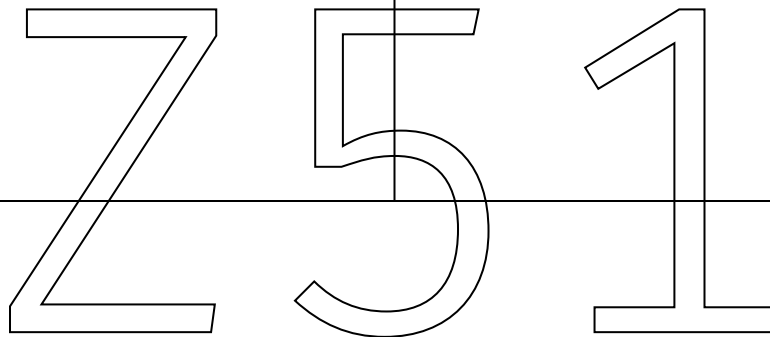

6,213 mm

Z52

4,393 × 6,213 mm

2,251,799,813,685,248 per Z0

≈ 8,962,379.642 km² lost due to rounding

Z51 ≡ zêta fifty-one

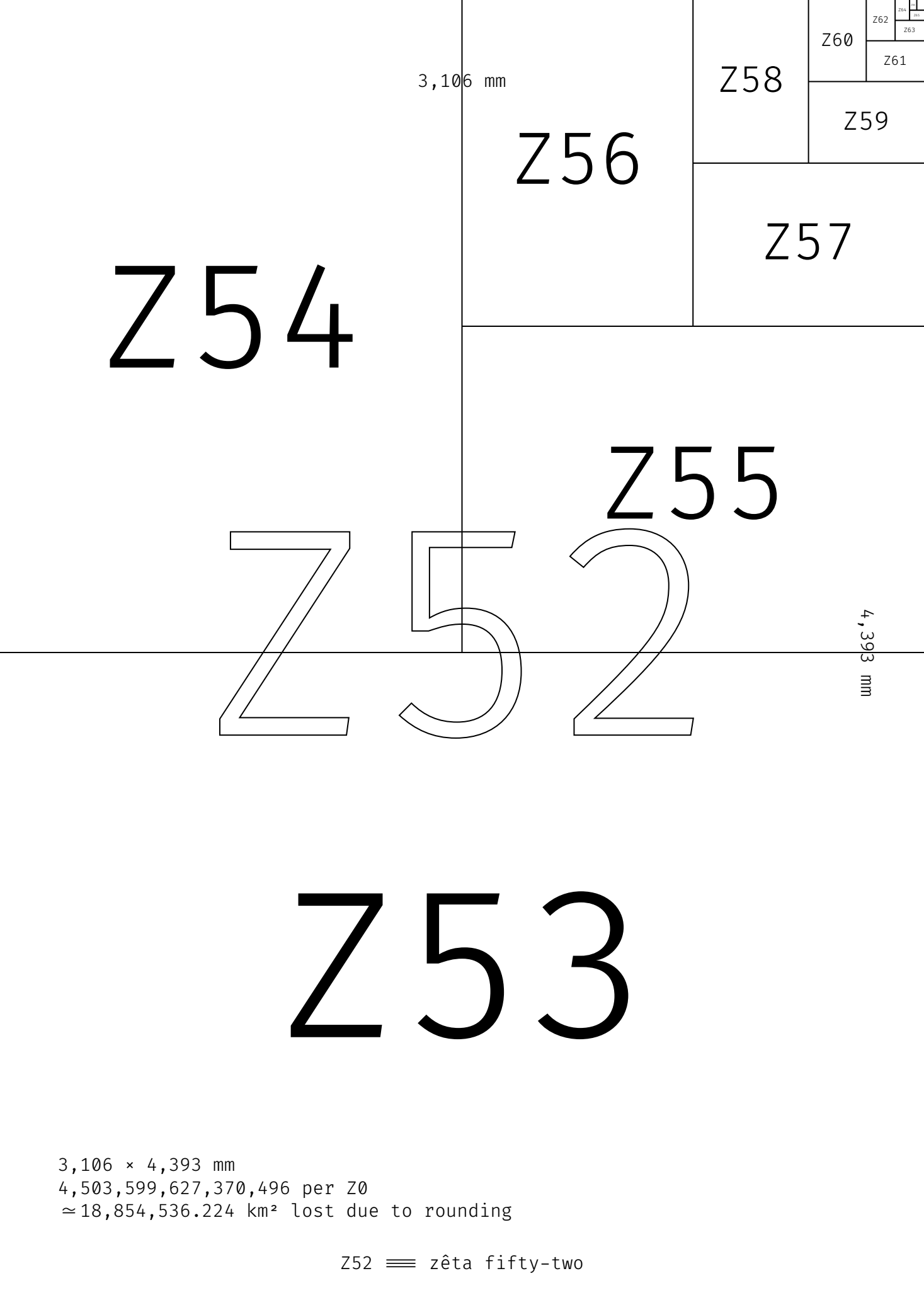

3,106 mm

Z60

Z62
Z63

Z61

Z58

Z59

Z56

Z57

Z54

Z55

Z 5 2

4,393 mm

Z53

3,106 × 4,393 mm

4,503,599,627,370,496 per Z0

≈ 18,854,536.224 km² lost due to rounding

Z52 ≡ zêta fifty-two

Z55

2,196 mm

Z57

Z59

Z61

Z63

Z64

Z62

Z60

Z58

Z56

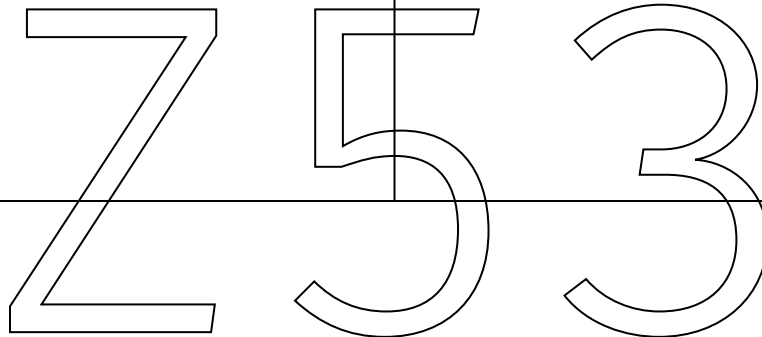

3,106 mm

Z54

2,196 × 3,106 mm

9,007,199,254,740,992 per Z0

≈ 32,842,716.666 km² lost due to rounding

Z53 ≡ zêta fifty-three

Z56

1,553 mm

Z58

Z60

Z62

Z64
Z65

Z63

Z61

Z59

Z57

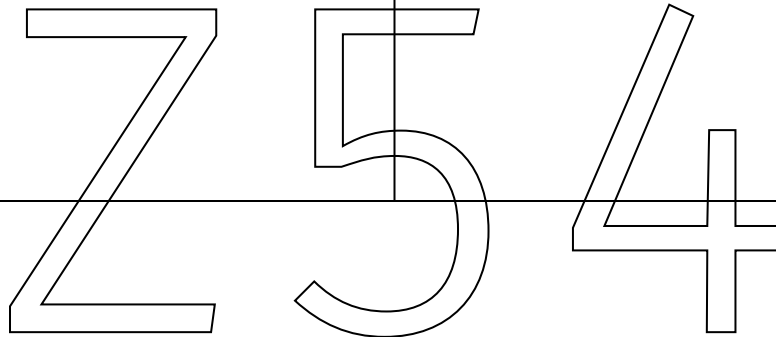

2,196 mm

Z55

1,553 × 2,196 mm

18,014,398,509,481,984 per Z0

≈ 32,842,716.666 km² lost due to rounding

Z54 ≡ zêta fifty-four

Z57

1,098 mm

Z59

Z61

Z63

Z65

Z66

Z64

Z62

Z60

Z58

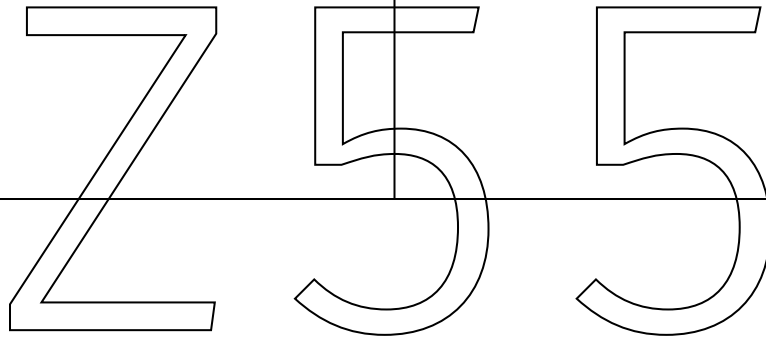

1,553 mm

Z56

1,098 × 1,553 mm

36,028,797,018,963,968 per Z0

≈ 32,842,716.666 km² lost due to rounding

Z55 ≡ zêta fifty-five

Z58

776 mm

Z60

Z62

Z64

Z66

Z65

Z63

Z61

Z59

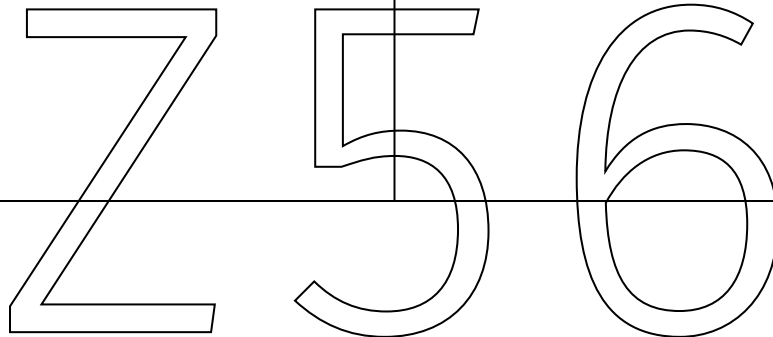

1,098 mm

Z57

776 × 1,098 mm

72,057,594,037,927,936 per Z0

≈ 72,402,335.793 km² lost due to rounding

Z56 ≡ zêta fifty-six

Z59

549 mm

Z61

Z63

Z65

Z66

Z64

Z62

Z60

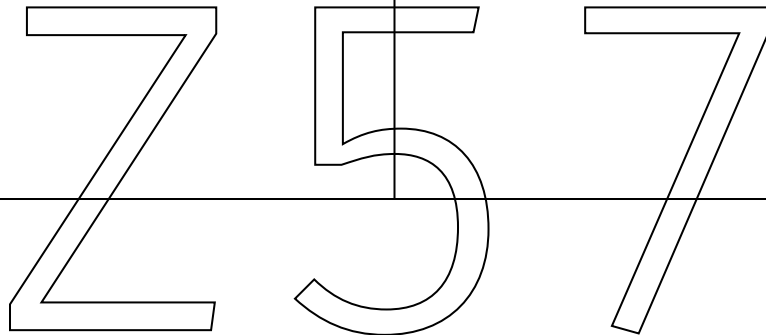

776 mm

Z58

549 × 776 mm

144,115,188,075,855,872 per Z0

≈ 72,402,335.793 km² lost due to rounding

Z57 ≡ zêta fifty-seven

Z60

388 mm

Z62

Z64

Z66

Z65

Z63

Z61

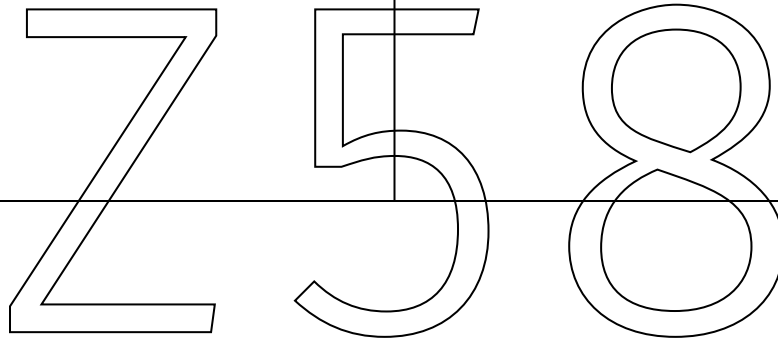

549 mm

Z59

388 × 549 mm

288,230,376,151,711,744 per Z0

≈ 72,402,335.793 km² lost due to rounding

Z58 ≡ zêta fifty-eight

274 mm

Z65

Z66

Z63

Z64

Z61

Z62

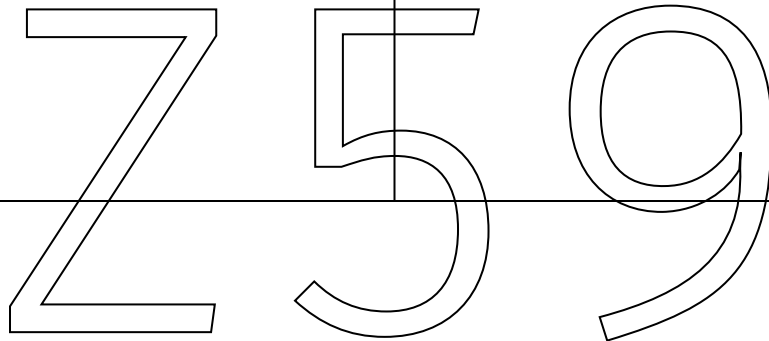

388 mm

Z60

274 × 388 mm

576,460,752,303,423,488 per Z0

≈ 184,235,721.74 km² lost due to rounding

Z59 ≡ zêta fifty-nine

194 mm

Z66

Z64

Z65

Z62

Z63

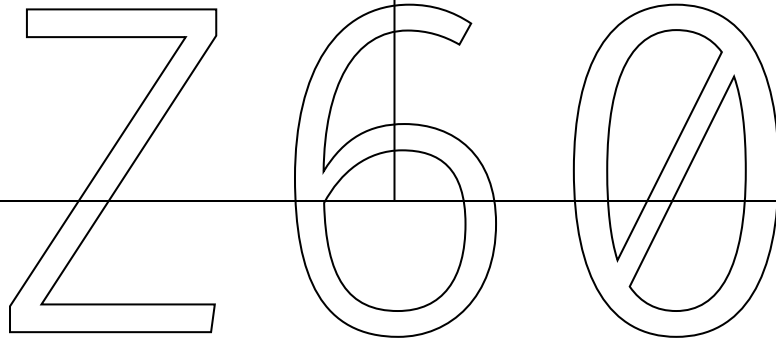

274 mm

Z61

194 × 274 mm

1,152,921,504,606,846,976 per Z0

≈ 184,235,721.74 km² lost due to rounding

Z60 ≡ zêta sixty

137 mm

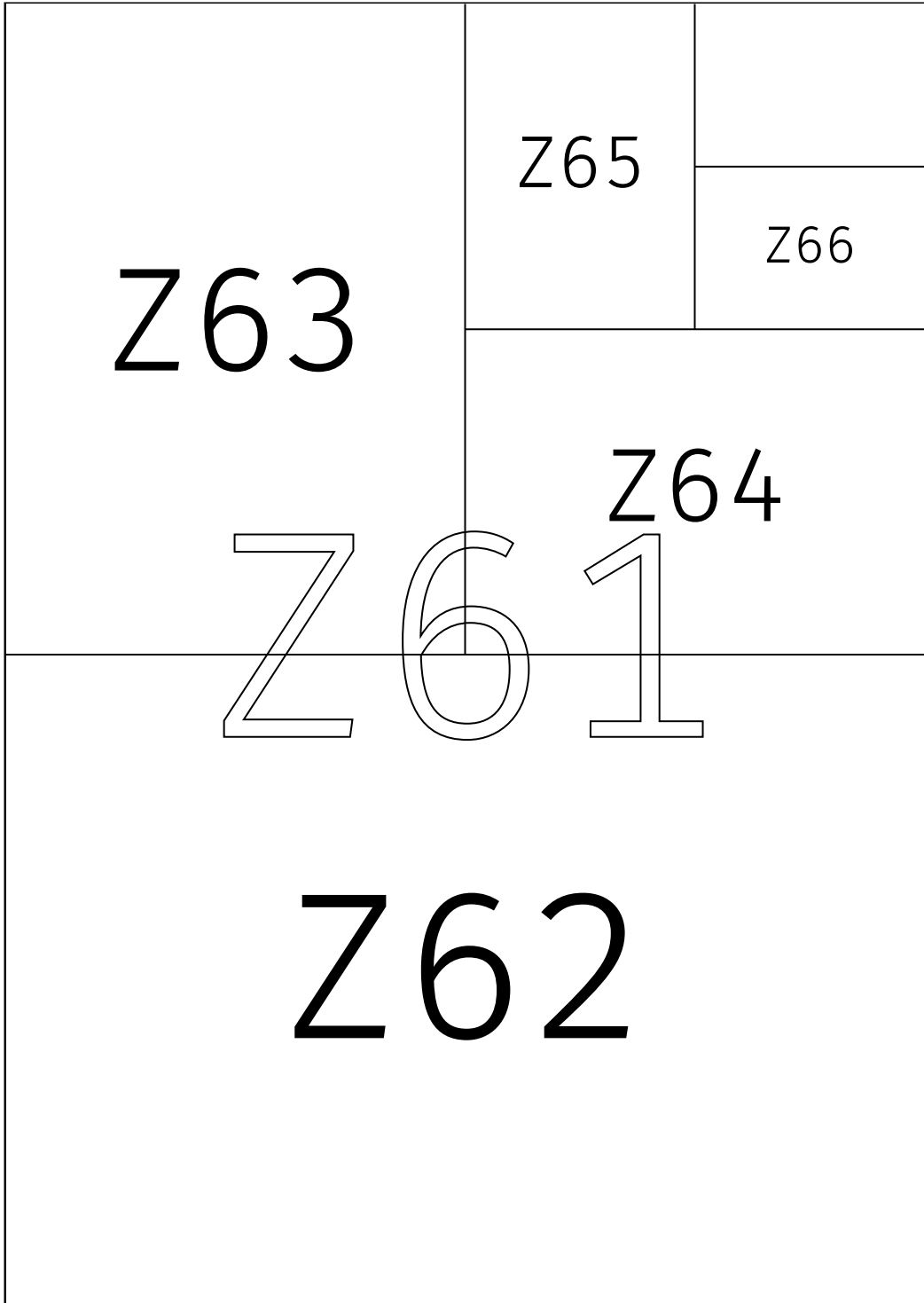

137 × 194 mm

2,305,843,009,213,693,952 per Z0

≈ 184,235,721.74 km² lost due to rounding

Z61 ≡ zêta sixty-one

97 mm

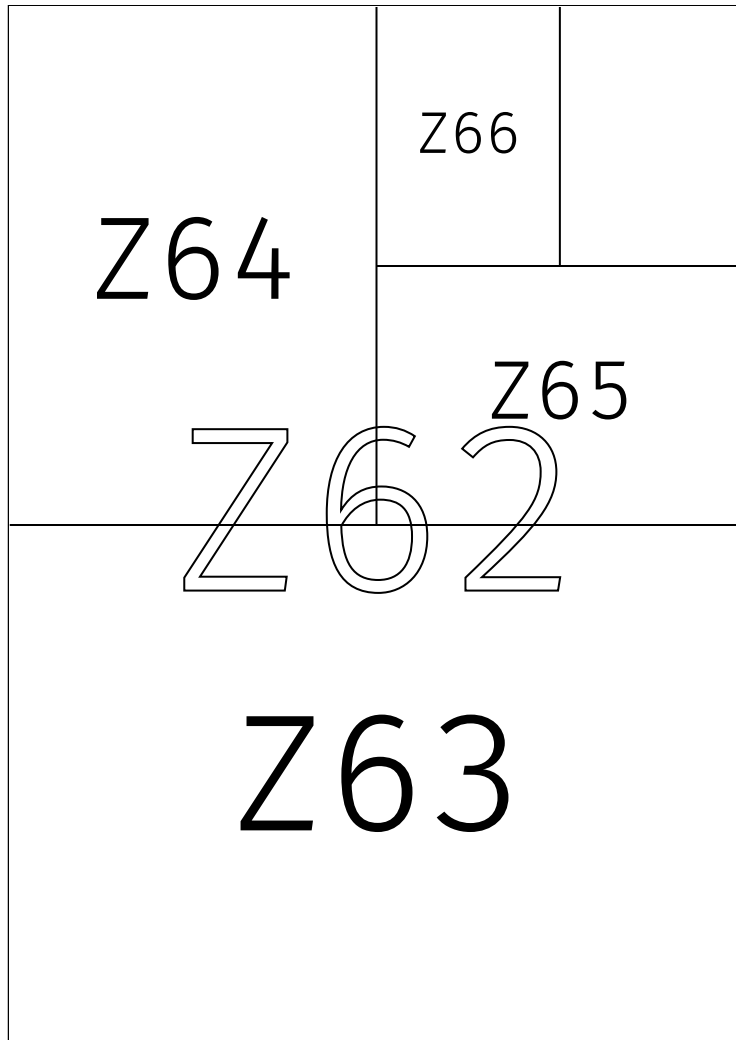

137 mm

97 × 137 mm
4,611,686,018,427,387,904 per Z0
≈ 184,235,721.74 km² lost due to rounding

Z62 ≡ zêta sixty-two

68 mm

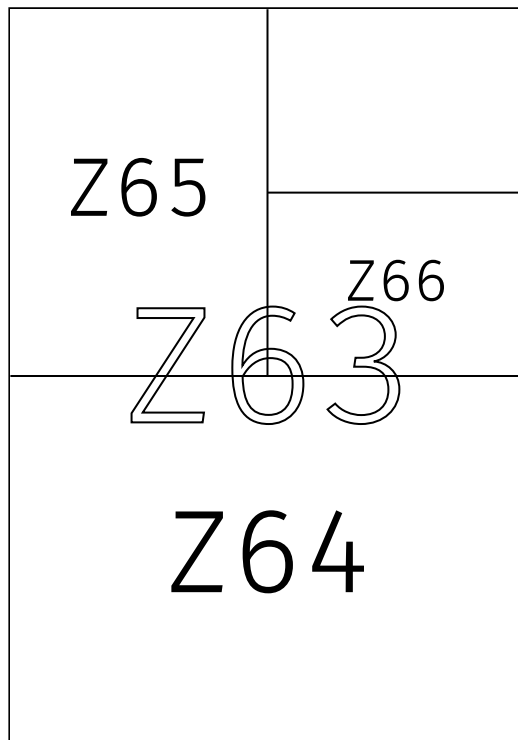

97 mm

68 × 97 mm

9,223,372,036,854,775,808 per Z0

≈ 631,569,265.528 km² lost due to rounding

Z63 ≡ zêta sixty-three

48 mm

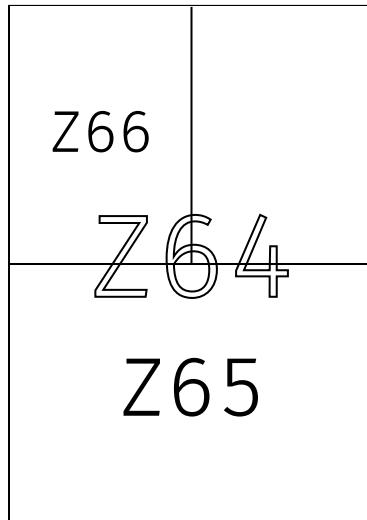

68 mm

48 × 68 mm

18,446,744,073,709,551,616 per Z0

≈ 1,258,758,564.034 km² lost due to rounding

Z64 ≡ zêta sixty-four

34 mm

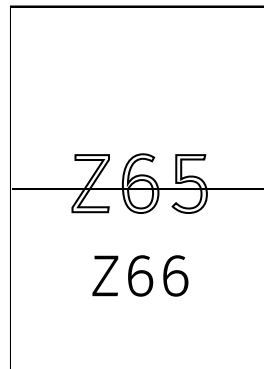

48 mm

34 × 48 mm

36,893,488,147,419,103,232 per Z0

≈ 1,258,758,564.034 km² lost due to rounding

Z65 ≡ zêta sixty-five

24 mm



34 mm

24 × 34 mm

73,786,976,294,838,206,464 per Z0

≈ 1,258,758,564.034 km² lost due to rounding

Z66 ≡ zêta sixty-six